

(19)



Europäisches Patentamt
European Patent Office
Office européen des brevets



(11)

EP 1 026 681 B1

(12)

EUROPEAN PATENT SPECIFICATION

(45) Date of publication and mention of the grant of the patent:
18.09.2002 Bulletin 2002/38

(51) Int Cl.7: **G11B 20/18**

(21) Application number: **00101918.1**

(22) Date of filing: **01.02.2000**

(54) Information recording medium, information recording method and information recording/reproduction system

Informationsaufzeichnungsmedium, Informationsaufzeichnungsverfahren, und Informationsaufzeichnungs/wiedergabe System

Support d'enregistrement de l'information, méthode d'enregistrement de l'information et système d'enregistrement/reproduction

(84) Designated Contracting States:
DE FR GB

(30) Priority: **01.02.1999 JP 2446299**

(43) Date of publication of application:
09.08.2000 Bulletin 2000/32

(60) Divisional application:
02007956.2 / 1 239 478

(73) Proprietor: **Matsushita Electric Industrial Co., Ltd. Kadoma-shi, Osaka 571-8501 (JP)**

(72) Inventors:
• **Gotoh, Yoshiho**
Osakashi, Osaka 536-0023 (JP)
• **Ito, Motoshi**
Osakashi, Osaka 536-0001 (JP)

- **Ueda, Hiroshi**
Hirakatashi, Osaka 573-1193 (JP)
- **Fukushima, Yoshihisa**
Osakashi, Osaka 536-0008 (JP)

(74) Representative: **Kügele, Bernhard et al**
Novagraaf SA
25, Avenue du Pailly
1220 Les Avanchets - Geneva (CH)

(56) References cited:
EP-A- 0 350 920 **US-A- 5 548 572**

- **"DYNAMIC SPARE SECTOR ALLOCATION IN HARD DISK DRIVE" IBM TECHNICAL DISCLOSURE BULLETIN,US,IBM CORP. NEW YORK, vol. 38, no. 5, 1 May 1995 (1995-05-01), page 257 XP000519571 ISSN: 0018-8689**

EP 1 026 681 B1

Note: Within nine months from the publication of the mention of the grant of the European patent, any person may give notice to the European Patent Office of opposition to the European patent granted. Notice of opposition shall be filed in a written reasoned statement. It shall not be deemed to have been filed until the opposition fee has been paid. (Art. 99(1) European Patent Convention).

Description

BACKGROUND OF THE INVENTION

1. FIELD OF THE INVENTION:

[0001] The present invention relates to an information recording medium, an information recording method and an information recording/reproduction system, in which it is possible to increase the reliability of data recording by dynamically extending the spare area according to the frequency of occurrence of defective sectors.

2. DESCRIPTION OF THE RELATED ART:

[0002] An optical disk is a type of information recording medium which has a sector structure. In recent years, as the recording density and the capacity of an optical disk have been increased, it has become more important to ensure the reliability thereof.

[0003] Conventionally, a defect management method is known in the art for managing defective sectors on the optical disk (i.e., sectors which cannot be used for recording/reproduction of data). A spare area is provided in advance on the optical disk. When there is a defective sector on the optical disk, the defective sector is replaced by another sector in the spare area. Thus, the reliability of the optical disk is ensured. Such a defect management method is described in International Standards Organization ISO/IEC 10090 for 90 mm optical disks.

[0004] The conventional defect management method described in the International Standards Organization ISO/IEC 10090 for 90 mm optical disks will now be outlined with reference to Figures 12 and 13.

[0005] Figure 12 illustrates a structure of a data recording area 800 of a conventional optical disk.

[0006] The data recording area 800 includes a plurality of sectors. Each of the plurality of sectors is assigned a physical sector number (hereinafter, referred to as a "PSN").

[0007] The data recording area 800 includes a defect management information area 801, a spare area 802 and a volume space 800a. The volume space 800a is arranged immediately after the spare area 802, and is defined as an area in which user data can be recorded. Each of the sectors included in the volume space 800a is assigned a logical sector number (hereinafter, abbreviated as an "LSN").

[0008] The size of the spare area 802 is predetermined. In order to change the size of the spare area 802, it is necessary to change the data structure of the replacement information stored in the defect management information area 801 by using a special command with physical format utility software. This operation will hereinafter be referred to as an initialization operation.

[0009] Figure 13 illustrates a procedure of a conven-

tional format operation and a conventional data write operation. These operations are performed by a system control apparatus and an optical disk drive apparatus. The optical disk drive apparatus is connected to the system control apparatus. The system control apparatus is, for example, a computer system.

[0010] The format operation includes steps S901-S903 illustrated in Figure 13. The data write operation includes steps S904-S911. In Figure 12, each reference numeral that starts with "S" beside an arrow denotes a recording operation corresponding to a step illustrated in Figure 13.

[0011] When an optical disk is inserted into the optical disk drive apparatus, the optical disk drive apparatus reads out the defect management information area 801 and recognizes replacement information which indicates that a defective sector has been replaced by a spare sector (step S901).

[0012] The system control apparatus performs a FAT/root directory creation operation, issues a Write command and transmits data to the optical disk drive apparatus (step S902).

[0013] The optical disk drive apparatus uses format utility software to recognize the physical structure of the optical disk and records the data transmitted from the system control apparatus from the beginning of the volume space 800a (step S903). As a result, a FAT area 803 and a root directory area 804 are arranged starting from the beginning of the volume space 800a. Such a logical format operation is similar to the format operation for a file system in a MS-DOS format. As a result, the area from immediately after the root directory area 804 to the end of the optical disk is handled as a file data space 800b which is managed by the FAT.

[0014] A data write operation for recording data (File-a) under the root directory will now be described.

[0015] The system control apparatus performs a recording operation for the data (File-a), issues a Write command and transmits data to the optical disk drive apparatus (step S904). The location at which the data should be recorded is specified by an LSN.

[0016] The optical disk drive apparatus records the data transmitted from the system control apparatus in a sector which is assigned the specified LSN (step S905). Whether or not the data has been correctly recorded is determined by reading out the recorded data and by comparing the read data with the transmitted data. When the data has not been correctly recorded, the sector which is assigned the specified LSN is detected as a defective sector. The defective sector occurs mainly due to dirt or dust attached to the optical disk.

[0017] For example, assume a case where sector b (sector 814) illustrated in Figure 12 has been detected as a defective sector. In such a case, the optical disk drive apparatus records the data which is supposed to be recorded in the defective sector 814 in #1 spare sector 810 of the spare area 802, generates, as defect management information, #1 replacement entry 832 which

indicates that the defective sector **814** has been replaced by the #1 spare sector **810**, and records the #1 replacement entry **832** in the defect management information area **801** (step S906).

[0018] The #1 replacement entry **832** includes location information **833** indicating the location of the defective sector and location information **834** indicating the location of the spare sector by which it is replaced. Each of the location information **833** and **834** is represented by a PSN.

[0019] When the system control apparatus instructs the optical disk drive apparatus to read out data from the defective sector **814**, the optical disk drive apparatus performs address conversion with reference to the #1 replacement entry **832** and reads out the data from the #1 spare sector **810**.

[0020] Thus, by replacing a defective sector by a spare sector, it is possible to ensure the reliability of the optical disk. Moreover, since such defective sector replacement operation is performed by the optical disk drive apparatus, it is possible to ensure that the system control apparatus always records data at a location corresponding to the specified LSN. As a result, the system control apparatus can handle the optical disk as a defect-free medium.

[0021] Then, the system control apparatus performs a root directory recording operation, issues a Write command and transmits data to the optical disk drive apparatus (step S907).

[0022] The optical disk drive apparatus updates root directory information recorded in the root directory area **804** according to the data transmitted from the system control apparatus (step S908).

[0023] The system control apparatus performs a FAT recording operation, issues a Write command and transmits data to the optical disk drive apparatus (step S909).

[0024] The optical disk drive apparatus updates FAT information recorded in the FAT area **803** according to the data transmitted from the system control apparatus (step S910). Thus, the data (File-a) is registered under the root directory.

[0025] The optical disk drive apparatus records the updated defect management information in the defect management information area **801**. Such recording is performed when there is no data recording instruction from the system control apparatus for a few seconds.

[0026] In the above-described conventional defect management method, the size of a spare area is fixed. Therefore, if there occurs defective sectors beyond the size of the replacement area, data cannot be recorded on the optical disk even when an unallocated area available for recording still exists on the optical disk. In order to record data on the optical disk, it is necessary to change the size of the spare area by performing another initialization operation on the optical disk. In such a case, data recorded in the volume space needed to be backed up on another medium before performing the initialization operation because the LSN allocation would

be changed over the entire area of the volume space.

[0027] Especially, in a case where an optical disk is used with consumer equipment, the user may handle the optical disk while eating food or a child may inadvertently touch the surface of the optical disk, whereby more defective sectors may occur on the optical disk than expected by the manufacturer.

[0028] Reference is made to EP-A-0350920 which describes a method of and an apparatus for managing defective sectors in an information recording medium such as a write-once optical disk and rewritable optical disk in which many defective sectors may be generated and unevenly distributed. In the medium, alternative zones are formed which are composed of: a prime area for recording user data the capacity of which is variable according to the volume capacity and partition capacity and the occurrence rate of defective sectors; a primary spare area for recording alternative sectors; and a primary defect list area for recording a primary defect list. Many defective sectors are managed in the units of alternative zones. When defective sectors cannot be substituted in an alternative zone (e.g., when defective sectors are locally concentrated), defective sectors are managed hierarchically using a secondary alternative area, thereby reducing the amount of information to be handled for the management of defective sectors. Therefore, the size of the apparatus can be reduced, and defective sectors can be rapidly searched.

[0029] Reference is also made to "Dynamic Spare Sector Allocation in Hard Disk Drive", IBM Technical Disclosure Bulletin, US, IBM Corp. New York, vo1. 38, no. 5, 1 May 1995, page 257, which describes a hard disk sector allocation method as follows: a first analysis of each disk surface is executed, and a map showing the amount of defects in each disk is produced. Then, according to the map, the number of spare sectors needed for each disk is determined, then the allocation of the spare sectors can be determined for each disk surface, then no shortage or surplus of spare sectors can happen, and an effective usage of data area can be achieved. Therefore, this method is applied dynamically to each disk at the disk formatting stage, rather than dynamically to the disk during use of the disk.

45 SUMMARY OF THE INVENTION

[0030] In a first aspect, the invention provides an information recording medium including a plurality of sectors, the information recording medium comprising a data recording area, the data recording area including:

a first spare area having a replacement area including a spare sector for replacing a defective area including a defective sector among the plurality of sectors;

a defect management information area in which defect management information for managing the re-

placement of the defective area including the defective sector by the replacement area including the spare sector is recorded; and
 a volume space in which user data can be recorded, wherein:

each of the sectors in the data recording area is assigned a physical sector number;
 in the data recording area, a second spare area having a replacement area including a spare sector for replacing a defective area including a defective sector among the plurality of sectors can be allocated in an area including a sector having a physical sector number which is larger than a physical sector number assigned to the spare sector in the first spare area, and the second spare area can be extended in a direction along which the physical sector number decreases; and
 the defect management information area has an area for recording location information which indicates allocation of the second spare area.

[0031] In a second aspect, the invention provides an information recording method for recording information on an information recording medium including a plurality of sectors, the information recording medium comprising a data recording area, the data recording area including:

a first spare area having a replacement area including a spare sector for replacing a defective area including a defective sector among the plurality of sectors;
 a defect management information area in which defect management information for managing the replacement of the defective area including the defective sector by the replacement area including the spare sector is recorded; and
 a volume space in which user data can be recorded, wherein:

in the data recording area, a second spare area having a replacement area including a spare sector for replacing a defective area including a defective sector among the plurality of sectors can be extended; and
 each of the spare sector in the first spare area and the spare sector in the second spare area is assigned a physical sector number, and the physical sector number assigned to the spare sector in the first spare area is smaller than the physical sector number assigned to the spare sector in the second spare area, the information recording method comprising the steps of:

(a) obtaining information which indicates a status of consumption of the second spare

area;
 (b) determining whether or not to extend, in the data recording area, the second spare area having a replacement area including a spare sector for replacing a defective area including a defective sector among the plurality of sectors according to the information which indicates the status of consumption of the second spare area; and
 (c) when the second spare area is extended, extending the second spare area in a direction along which the physical sector number decreases.

[0032] In a third aspect, the invention provides an information recording/reproduction system for an information recording medium including a plurality of sectors, the information recording medium comprising a data recording area, the data recording area including:

a first spare area having a replacement area including a spare sector for replacing a defective area including a defective sector among the plurality of sectors;
 a defect management information area in which defect management information for managing the replacement of the defective area including the defective sector by the replacement area including the spare sector is recorded; and
 a volume space in which user data can be recorded, wherein:

in the data recording area, a second spare area having a replacement area including a spare sector for replacing a defective area including a defective sector among the plurality of sectors can be extended; and
 each of the spare sector in the first spare area and the spare sector in the second spare area is assigned a physical sector number, and the physical sector number assigned to the spare sector in the first spare area is smaller than the physical sector number assigned to the spare sector in the second spare area, the information recording/reproduction system comprising:

a remaining spare area amount detection section for obtaining information which indicates a status of consumption of the second spare area;
 a spare area extension determination section for determining whether or not to extend, in the data recording area, the second spare area having a replacement area including a spare sector for replacing a defective area including a defective sector among the plurality of sectors according to

the information which indicates the status of consumption of the second spare area; and

a spare extension area allocation section for when the second spare area is extended, extending the second spare area in a direction along which the physical sector number decreases.

[0033] Thus, the invention described herein makes possible the advantage of providing an information recording medium, an information recording method and an information recording/reproduction system, in which it is possible to increase the reliability of data recording by dynamically extending the spare area according to the frequency of occurrence of defective sectors.

[0034] This and other advantages of the present invention will become apparent to those skilled in the art upon reading and understanding the following detailed description with reference to the accompanying figures.

BRIEF DESCRIPTION OF THE DRAWINGS

[0035]

Figure 1 is a diagram illustrating a structure of a data recording area 100 of an optical disk according to an embodiment of the present invention;

Figure 2 is a block diagram illustrating a structure of an information recording/reproduction system 1a according to an embodiment of the present invention;

Figure 3 is a protocol chart illustrating a procedure of a format operation;

Figure 4 is a diagram illustrating a structure of the data recording area 100 of an optical disk after a format operation;

Figure 5 is a protocol chart illustrating a procedure of a data write operation;

Figures 6A-6C are protocol charts illustrating a procedure of an operation of determining whether or not it is necessary to extend a first spare area 102;

Figure 7 is a protocol chart illustrating a procedure of an operation of extending the first spare area 102 and a second spare area 108;

Figure 8 is a diagram illustrating a structure of the data recording area 100 of an optical disk according to an embodiment of the present invention;

Figure 9 is a protocol chart illustrating a procedure

of a data write operation for recording a file on an optical disk;

Figure 10 is a protocol chart illustrating a procedure of an operation which is performed when an optical disk is inserted into an optical disk drive apparatus;

Figure 11 is a diagram illustrating an operation of updating volume structure areas 103 and 109 and a basic file structure area 104;

Figure 12 is a diagram illustrating a structure of a data recording area 800 of a conventional optical disk; and

Figure 13 is a protocol chart illustrating a procedure of a conventional format operation and a conventional data write operation.

DESCRIPTION OF THE PREFERRED EMBODIMENTS

[0036] An information recording medium of the present invention includes a first spare area including a spare sector for replacing a defective sector, a defect management information area for managing replacement of a defective sector by a spare sector, and a volume space in which user data can be recorded.

[0037] The volume space is configured so that a second spare area including a spare sector for replacing a defective sector can be additionally allocated. When all of the spare sectors provided in advance in the first spare area have been consumed by the defective sector replacement operation, a part of the volume space is made available as a second spare area. Thus, by additionally allocating the second spare area when necessary, it is possible to ensure the defect-free property of the optical disk even when there occurs more defective sectors than expected by the manufacturer of the optical disk.

[0038] Location information indicating the location of the second spare area is recorded in the defect management information area.

[0039] Embodiments of the present invention will now be described with reference to the drawings.

[0040] Embodiment 1 is an embodiment in which the second spare area is allocated inside the volume space by updating the file structure. Embodiment 2 is an embodiment in which the second spare area is allocated outside the volume space by updating the volume structure and the file structure.

(Embodiment 1)

[0041] Figure 2 illustrates a structure of an information recording/reproduction system 1a according to an embodiment of the present invention. The information recording/reproduction system 1a records information on

the information recording medium and reproduces information recorded on the information recording medium. The information recording medium may be any type of rewritable optical disk such as a DVD-RAM.

[0042] It is assumed in the following description that the information recording medium is a rewritable optical disk on/from which files managed by a file structure defined in the ECMA167 standard can be recorded/reproduced by sectors. Hereinafter, such a rewritable optical disk will be referred to simply as an optical disk.

[0043] As illustrated in Figure 2, the information recording/reproduction system **1a** includes a system control apparatus **200** and an optical disk drive apparatus **204**. The system control apparatus **200** and the optical disk drive apparatus **204** are connected to each other via an I/O bus **203**.

[0044] The system control apparatus **200** includes a system control section **201** for processing file structure information and a memory circuit **202**. The system control section **201** may be implemented by, for example, a microprocessor including a control program and a memory for storing operation results.

[0045] The system control section **201** includes: a file structure operation section **211** for performing a bit map operation for managing unallocated areas in a logical volume space; a spare extension area detection section **212** for examining whether or not an area which is determined to be allocated as an additional spare area has already been used; a file moving operation section **213** for allocating an additional spare area by moving a file recorded in the area which is determined to be allocated as an additional spare area to another area; a spare extension area allocation section **214** for registering an additional spare area in a file structure; a spare area extension determination section **215** for determining whether or not the spare area should be extended based on the amount of spare area remaining; a command status operation section **216** for recognizing whether or not a defective sector has been detected during data recording by the execution result of a Write command; and a spare extension area issue section **217** for directing a spare area to be extended for the optical disk drive apparatus **204** for updating the defect management information.

[0046] The memory circuit **202** includes a file structure memory **221**, a bit map memory **222**, a data memory **223**, and a spare area information memory **224** for storing information indicating the amount of spare area remaining and information indicating the location of the spare area.

[0047] The optical disk drive apparatus **204** includes a drive control section **205** for performing a defect management operation and controlling the recording/reproduction of data on/from the optical disk, and a memory circuit **206**. The drive control section **205** may be implemented by, for example, a microprocessor including a control program and a memory for arithmetic operations.

[0048] The drive control section **205** includes: a remaining spare amount reporting section **231** for reporting the area size which can be replaced by the spare area; a spare area allocation section **232** for updating defect management information according to a spare area extension command from the system control apparatus **200**; a remaining spare area amount detection section **233** for detecting the area which can be replaced by the spare area based on a replacement entry of the defect management information area; a defective sector operation section **234** for allocating a defective sector detected during data recording by a spare sector of the spare area and recording data in the spare sector; a data write control section **235** for controlling recording of data to the optical disk; and a data read control section **236** for controlling reproduction of data from the optical disk.

[0049] The memory circuit **206** includes a defect management information memory **241** for storing the defect management information, and a data memory **242**.

[0050] A format operation performed on an optical disk according to the present invention will now be described with reference to Figures 1, 2, 3 and 4.

[0051] Figure 4 illustrates a structure of the data recording area **100** of an optical disk after the format operation.

[0052] The data recording area **100** includes a plurality of sectors. Each of the plurality of sectors is assigned a PSN.

[0053] The data recording area **100** includes a defect management information area **101**, a first spare area **102** and a volume space **100a**.

[0054] Defect management information **130** is recorded in the defect management information area **101**. The defect management information **130** includes an SDL descriptor **131** for identifying SDL information, a spare area full flag **132**, location information **133** indicating the location of the second spare area **108**, and #1 replacement entry **134** indicating that a defective sector has been replaced by a spare sector.

[0055] The spare area full flag **132** includes a first full flag **138** for the first spare area **102** and a second full flag **139** for the second spare area **108**. The first full flag **138** indicates whether or not there is any spare sector available in the first spare area **102**. The second full flag **139**, when it is reset, indicates that there is a spare sector available in the second spare area **108**. The second full flag **139**, when it is set, indicates that there is no more spare sector available in the second spare area **108** or that no second spare area **108** has been allocated.

[0056] Hereinafter, the location information **133** indicating the location of the second spare area **108** will be referred to simply as the "second spare area location information **133**". The second spare area location information **133** is represented by, for example, the PSN of the first sector included in the second spare area **108** and the PSN of the last sector included in the second spare area **108**.

[0057] In the example illustrated in Figure 4, the sec-

ond spare area has not yet been allocated on the data recording area **100**. In such a case, the second spare area location information **133** has a value (e.g., the NULL value) which indicates that "the second spare area has not yet been allocated on the data recording area **100**".

[0058] In the example illustrated in Figure 4, the number of replacement entries included in the defect management information **130** is 1. The defect management information **130** may include a number of replacement entries equal to the number of spare sectors replacing defective sectors. Therefore, when the number of spare sectors replacing defective sectors is N, the defect management information **130** may include #1-#N replacement entries. Herein, N is any integer. Each of the #1-#N replacement entries includes location information **136** indicating the location of the defective sector and location information **137** indicating the location of the spare sector replacing the defective sector. Each of the location information **136** and **137** is represented by, for example, a PSN.

[0059] The size of the first spare area **102** is fixed. In the example illustrated in Figure 4, the first spare area **102** includes three spare sectors **110-112**, i.e., #1 spare sector to #3 spare sector. Each of the spare sectors **110-112** is used to replace a defective sector. The number of spare sectors included in the first spare area **102** is not limited to 3. The first spare area **102** may include any number of spare sectors.

[0060] The volume space **100a** is arranged immediately after the first spare area **102**, and is defined as an area in which user data can be recorded. Each of the sectors included in the volume space **100a** is assigned a logical sector number. The volume space **100a** includes the volume structure area **103**, a logical volume space **100b** and the volume structure area **109**.

[0061] Figure 3 illustrates a procedure of a format operation. The format operation is performed by the system control apparatus **200** and the optical disk drive apparatus **204**.

[0062] The format operation includes steps S301-S307 illustrated in Figure 3. In Figure 4, each reference numeral that starts with "S" beside an arrow denotes a recording operation corresponding to a step illustrated in Figure 3.

[0063] When the optical disk is inserted into the optical disk drive apparatus **204**, the defect management information **130** is read out from the defect management information area **101**. The defect management information **130** is stored in the defect management information memory **241**.

[0064] The defect management information **130** stored in the defect management information memory **241** is referenced by the remaining spare amount reporting section **231** and the remaining spare amount detection section **233**, as will be described below.

[0065] The remaining spare area amount detection

section **233** recognizes the location information of the first and second spare areas and the status of consumption of the first and second spare areas (step S301). The status of consumption of each spare area is recognized by, for example, retrieving one of the replacement entries recorded in the defect management information area **101** that has the smallest address information (e.g., the physical sector number) of a spare sector.

[0066] The file structure operation section **211** issues a Get Spare Info command to the optical disk drive apparatus **204** in order to inquire as to the spare area information (step S302).

[0067] The remaining spare amount reporting section **231** reports the spare area information to the system control apparatus **200** based on the defect management information **130** stored in the defect management information memory **241** (step S303). The spare area information includes the location information **133** indicating the location of the second spare area. The spare area information is stored in the spare area information memory **224**.

[0068] The file structure operation section **211** performs a volume structure/basic file structure creation operation and issues a Write command and transmits data to the optical disk drive apparatus **204** (step S304). The data is once stored in the file structure memory **221**, and then transferred from the file structure memory **221** to the data memory **242**.

[0069] The data write control section **235** records data stored in the data memory **242** starting from the beginning of the volume space **100a** (i.e., the sector assigned the LSN "0") (step S305). As a result, the volume structure area **103** and the basic file structure area **104** are allocated starting from the beginning of the volume space **100a**.

[0070] Although not shown in Figure 4, an anchor volume descriptor pointer, a volume descriptor sequence, a file set descriptor, a file entry for the system stream directory and the system stream directory are recorded in the volume structure area **103**.

[0071] The basic file structure area **104** includes a space bit map area **113**, a file entry area **114**, a root directory area **115** and a file entry area **116**.

[0072] A space bit map is recorded in the space bit map area **113**. The space bit map is a string of bits which indicates the allocation status in each sector of the logical volume space **100b**. By referencing the space bit map, it is possible to examine the status of consumption of each sector in the logical volume space **100b**.

[0073] The location information and management information for the root directory area **115** are recorded in the file entry area **114**.

[0074] The names of the files recorded under the root directory and the location information for the file entry of each of such files are recorded in the root directory area **115**.

[0075] A file entry specified by the system stream directory is recorded in the file entry area **116**. The loca-

tion information of the stream of the second spare area to be registered in the system stream directory is managed by this file entry. The file entry includes a descriptor tag **141** for identifying the file entry, a file attribute **142** and location information **143** indicating the location of the second spare area **108**.

[0076] Hereinafter, the location information **143** indicating the location of the second spare area **108** will be referred to simply as the "second spare area location information **143**". The second spare area location information **143** is represented by, for example, the LSN of the first sector included in the second spare area **108** and the size of the second spare area **108**.

[0077] In the format operation, information equivalent to the second spare area location information **133** included in the defect management information **130** is recorded in the file entry area **116** as the second spare area location information **143**. In the example illustrated in Figure 4, the second spare area location information **133** has the NULL value, as discussed above. Accordingly, the second spare area location information **143** also has the NULL value.

[0078] Whether or not the data transmitted from the system control apparatus **200** has been correctly recorded in the volume structure area **103** and the basic file structure area **104** is determined by reading out the recorded data and by comparing the read data with the transmitted data (i.e., the data stored in the data memory **242**). Such a determination is performed by the defective sector operation section **234**.

[0079] For example, when the data transmitted from the system control apparatus **200** is not correctly recorded in the root directory area **115**, the root directory area **115** is detected as a defective sector. In such a case, the defective sector operation section **234** replaces the root directory area **115** by one of the available spare sectors included in the first spare area **102** that has the largest address (i.e., the #1 spare sector **112**). As a result, data which is supposed to be recorded in the root directory area **115** is recorded in the #1 spare sector **112** of the first spare area **102**. Moreover, the defective sector operation section **234** generates the #1 replacement entry **134** which indicates that the root directory area **115** has been replaced by the #1 spare sector **112** and stores the #1 replacement entry **134** in the defect management information memory **241** (step S306).

[0080] The defective sector operation section **234** records the updated defect management information **130** stored in the defect management information memory **241** in the defect management information area **101** (step S307). Such recording is performed immediately after step S306 or when there is no command to record the data from the system control apparatus **200** for a predetermined period of time (e.g., 5 seconds).

[0081] As described above, in the optical disk format operation, information that has consistency with the second spare area location information **133** recorded in the defect management information area **101** is recorded in

the basic file structure area **104** as the second spare area location information **143**. By performing the above-described format operation on a used optical disk, it is possible to reuse the used optical disk. This is because even if all of the information in the volume space **100a** is erased, the information in the second spare area is stored in the defect management information area **101**.

[0082] The second spare area location information **143** is managed by the system control apparatus **200**, and the second spare area location information **133** is managed by the optical disk drive apparatus **204**. It is necessary to ensure that the location information **143** and **133** always have consistency with each other. Countermeasures which can be taken when the information **143** and **133** are not consistent with each other and a method for recovering the inconsistency between the information **143** and **133** will be described later.

[0083] A data write operation of recording a file named "File-a" under the root directory of a formatted optical disk will now be described with reference to Figures 1, 2 and 5.

[0084] Figure 1 illustrates a structure of the data recording area **100** of the optical disk after the data write operation.

[0085] Figure 5 illustrates a procedure of the data write operation. The data write operation is performed by the system control apparatus **200** and the optical disk drive apparatus **204**.

[0086] The data write operation includes steps S401-S417 illustrated in Figure 5. In Figure 1, each reference numeral that starts with "S" beside an arrow denotes a recording operation corresponding to a step illustrated in Figure 5.

[0087] When the optical disk is inserted into the optical disk drive apparatus **204**, the same defect management information operation as that done in the format operation is performed as a start-up operation for the optical disk drive apparatus **204** (step S401).

[0088] The file structure operation section **211** issues a Read command to the optical disk drive apparatus **204** as a start-up operation for the system control apparatus **200** (step S402).

[0089] The data read control section **236** reproduces data from the volume structure area **103** and the basic file structure area **104** according to the address specified by the Read command and transmits the reproduced data to the file structure memory **221** (step S403).

[0090] The file structure operation section **211** analyzes the volume structure and the basic file structure based on the data transmitted to the file structure memory **221**. As a result, the file structure operation section **211** recognizes the logical volume space **100a** based on the data reproduced from the volume structure area **103**, recognizes the location and the size of an unallocated area **107** based on the data reproduced from the space bit map area **113**, recognizes the directory structure based on the data reproduced from the root directory area **115**, and recognizes the second spare area

location information **143** based on the data reproduced from the file entry area **116** (step S402).

[0091] The file structure operation section **211** creates data of a file named "File-a" and stores the data in the data memory **223**. Moreover, the file structure operation section **211** creates data of a file entry and stores the data in the file structure memory **221**. The file structure operation section **211** issues a Write command and each data to the optical disk drive apparatus **204** (step S404). The Write command is used to record each data at the address of the unallocated area **107** recognized in step S402.

[0092] The data stored in the data memory **223** and the data stored in the file structure memory **221** are transmitted to the data memory **242**. The data write control section **235** records the respective data transmitted in the data memory **242** in a data area **105** and in a file structure area **106** according to the addresses specified by the Write command (step S405).

[0093] The defective sector operation section **234** performs a replacement operation by the same method as that described in the description of the format operation. For example, assume a case where sector b (sector **118**) illustrated in Figure 1 has been detected as a defective sector. In such a case, the defective sector operation section **234** records the data, which is supposed to be recorded in the defective sector **118**, in #2 spare sector **111** of the first spare area **102**, generates #2 replacement entry **135** which indicates that the defective sector **118** has been replaced by the #2 spare sector **111**, and records the #2 replacement entry **135** in the defect management information memory **241** (step S406).

[0094] In order to register the file (File-a) under the root directory, it is necessary to update the data recorded in the root directory area **115**. The file structure operation section **211** issues the Write command and transmits the data to the optical disk drive apparatus **204** (step S407).

[0095] The data write control section **235** references the #1 replacement entry **134**, converts the address of the root directory area **115** specified by the Write command to the address of the #1 spare sector **112**, and records the data transmitted from the system control apparatus **200** in the #1 spare sector **112** (step S408).

[0096] The spare area extension determination section **215** determines, based on the status of consumption of the first spare area **102**, whether or not it is necessary to extend the first spare area **102**. There are various methods for such a determination. The details of such various methods will later be described with reference to Figures **6A-6C**.

[0097] Herein, an example of such determination methods will be described. For example, the spare area extension determination section **215** issues a Get Event Status Notification command to the optical disk drive apparatus **204**. This command is used to inquire as to the status of consumption of the first spare area **102**. In re-

sponse to this inquiry, the spare area extension determination section **215** determines that it is necessary to extend the first spare area **102** when the optical disk drive apparatus **204** reports shortage information which indicates that the remaining amount of the first spare area **102** is less than a predetermined size (e.g., 1 MB) (step S409).

[0098] In response to the command issued from the system control apparatus **200** in step S409, the remaining spare area amount detection section **233** calculates the remaining amount of the first spare area **102** (e.g., the number of spare sectors in the first spare area **102** that are available for replacement) based on the information of the replacement entry stored in the defect management information memory **241**. If the remaining amount is less than the predetermined size, the remaining spare area amount detection section **233** instructs the remaining spare amount reporting section **231** to report the shortage information to the system control apparatus **200**. The remaining spare amount reporting section **231** reports the shortage information to the system control apparatus **200** (step S410).

[0099] In the example illustrated in Figure 1, the defective sector **118** is detected when recording data in the data area **105**, and the #2 spare sector **111** is used to replace the defective sector **118**. Therefore, the #3 spare sector **110** is the only spare sector in the first spare area **102** that is available for replacement. Then, if another defective sector occurs, the first spare area **102** would be exhausted, whereby no more replacement operation can be done. Therefore, the remaining spare amount reporting section **231** reports the shortage information to the system control apparatus **200**.

[0100] In order to enlarge spare area, it is necessary to update the file entry area **116**, the location information **133** indicating the location of the second spare area **108**, and the space bit map area **113**.

[0101] The system control apparatus **200** recognizes the unallocated area **107** based on the data reproduced from the space bit map area **113** and determines the area to be reserved as an additional spare area (i.e., the area where the second spare area **108** is allocated). The system control apparatus **200** updates the data stored in the file structure memory **221** in order to register the extended spare area, and updates the data stored in the bit map memory **222** so that the sectors of the area where the second spare area **108** is to be allocated are indicated as "allocated".

[0102] The system control apparatus **200** issues a Write command and transmits the data for the file entry area **116** stored in the file structure memory **221** to the optical disk drive apparatus **204** (step S411).

[0103] The optical disk drive apparatus **204** updates the file entry area **116** by recording the data transmitted from the system control apparatus **200** in the file entry area **116** (step S412).

[0104] The system control apparatus **200** issues an Alloc Spare command and transmits the data for updat-

ing the second spare area location information **133** to the optical disk drive apparatus **204** (step S413).

[0105] The optical disk drive apparatus **204** updates the second spare area location information **133** stored in the defect management information memory **241** based on the data transmitted from the system control apparatus **200** (step S414).

[0106] Through the operations of steps S412 and S414, the second spare area **108** becomes available as an added spare area in the optical disk drive apparatus **204**. In the example illustrated in Figure **1**, the second spare area **108** includes #4 spare sector **122** to #6 spare sector **120**. The number of spare sectors included in the second spare area **108** is not limited to **3**. The second spare area **108** may include any number of spare sectors.

[0107] The file structure operation section **211** transmits the data for the space bit map area **113** stored in the file structure memory **221** to the optical disk drive apparatus **204** (step S415).

[0108] The data write control section **235** updates the space bit map area **113** by recording the data transmitted from the system control apparatus **200** in the space bit map area **113** (step S416).

[0109] The defective sector operation section **234** records in the defect management information area **101** the data which is stored in the defect management information memory **241** by the method described above in the procedure of the exemplary format operation (step S417).

[0110] As described above, in the data write operation for recording a file on the optical disk, it is possible to extend the first spare area **102** (i.e., to additionally allocate the second spare area **108**) based on the status of consumption of the first spare area **102**. Thus, it is possible to increase the reliability of data recording without performing an initialization operation.

[0111] When recording a file on the optical disk, the file structure operation section **211** may determine locations where data can be recorded, sequentially starting from a sector with the least LSN. In this way, data is recorded preferentially from the inner periphery of the optical disk, so that data is less likely to be recorded in an area to which the second spare area is extended, whereby it is possible to easily extend the spare area without moving files.

[0112] While an optical disk including the first spare area has been described in the above embodiment, the present invention may alternatively be applied to an optical disk in which the first spare area does not exist. For example, it is possible not to allocate the second spare area when there is no defective sector, while additionally allocating the second spare area when there occurs a defective sector. With such a defect management method, it is possible to obtain effects similar to those realized in the above-described embodiment.

[0113] Next, a method for determining whether or not it is necessary to extend the first spare area **102** will be

described with reference to Figures **1**, **2** and **6A-6C**. This method may alternatively be applied to a determination of whether or not it is necessary to extend the second spare area **108**.

[0114] Figures **6A-6C** are protocol charts illustrating an procedure of an operation of determining whether or not it is necessary to extend the first spare area **102**. This operation is performed by the optical disk drive apparatus **204** and the system control apparatus **200**.

[0115] Figure **6A** illustrates an operation performed when the optical disk is inserted into the optical disk drive apparatus **204**.

[0116] As described above, when the optical disk is inserted into the optical disk drive apparatus **204**, the file structure operation section **211** reproduces the volume structure area **103** and the basic file structure area **104** and instructs the data read control section **236** to transmit the reproduced data to the file structure memory **221** (step S402 in Figure **5**).

[0117] The file structure operation section **211** analyzes the basic file structure based on the data transmitted to the file structure memory **221**. As a result, the file structure operation section **211** calculates the size of area in the logical volume space **100b** that is available for recording based on the data reproduced from the space bit map area **113**. The size of area is calculated by, for example, summing the number of sectors in the unallocated area **107**. The calculation result is stored in the spare area information memory **224**.

[0118] The file structure operation section **211** issues a Get Spare Info command to the optical disk drive apparatus **204** in order to inquire as to the remaining amount of the first spare area **102** (step S601).

[0119] The remaining spare area amount detection section **233** calculates the remaining amount of the first spare area **102** (e.g., the number of spare sectors that are available for replacement) by the method as described above in the description of the format operation, and the remaining spare amount reporting section **231** reports the calculation result to the system control apparatus **200** (step S602). The information indicating the remaining amount of the first spare area **102** is stored in the spare area information memory **224**.

[0120] The spare area extension determination section **215** calculates the ratio (A/B) of the remaining amount (A) of the first spare area **102** with respect to the size of area (B) in the logical volume space **100b** that is available for recording, and determines that the first spare area **102** should be extended if the ratio (A/B) is less than a predetermined ratio (e.g., 0.5%) (step S603).

[0121] The determination operation illustrated in Figure **6A** is performed upon insertion of the optical disk before data is recorded thereon. The determination operation has features that the procedure of the determination operation is simple and that the implementation of the determination operation is easy.

[0122] Figure **6B** illustrates an operation performed

when recording a file. In the operation illustrated in Figure 6B, when a file is recorded on the optical disk, it is determined before recording the file whether or not it is necessary to extend the first spare area 102. Such a determination is performed based on the size of the data to be recorded and the remaining amount of the first spare area 102.

[0123] The file structure operation section 211 stores the data to be recorded on the optical disk in the data memory 223 and calculates the size of the data. The calculation result is stored in the spare area information memory 224.

[0124] The file structure operation section 211 issues a Get Event Status Notification command to the optical disk drive apparatus 204 in order to inquire as to the status of consumption of the first spare area 102 (step S604).

[0125] The remaining spare area amount detection section 233 calculates the remaining amount of the first spare area 102 by the method described above in the description of the format operation. If the remaining amount of the first spare area 102 is less than a predetermined size (e.g., 1 MB), the remaining spare amount reporting section 231 reports shortage information indicating the shortage of the first spare area 102 to the system control apparatus 200 (step S605). The shortage information is stored in the spare area information memory 224.

[0126] The spare area extension determination section 215 determines whether or not the first spare area 102 should be extended based on the size of the data to be recorded and the shortage information (step S606). For example, when the size of the data to be recorded is greater than the remaining amount of the first spare area 102, the spare area extension determination section 215 determines that the first spare area 102 should be extended.

[0127] With the determination operation illustrated in Figure 6B, it is possible to allocate the spare area according to the size of the file to be recorded. Therefore, the operation has features that it is possible to reasonably ensure the reliability of data recording, assuming that the frequency of occurrence of defective sectors is statistically substantially constant.

[0128] Figure 6C illustrates an operation performed in data transmission.

[0129] When a file is recorded on the optical disk, the data of the file is divided into a plurality of data portions. For example, when data having a size of 1 MB is recorded on the optical disk, the data is divided into a plurality of data portions each having a size of 32 kB.

[0130] A Write command is issued for each of the data portions. As a result, each of the data portions is transmitted from the system control apparatus 200 to the optical disk drive apparatus 204.

[0131] In the operation illustrated in Figure 6C, it is determined whether or not the first spare area 102 should be extended each time a data portion is trans-

mitted.

[0132] The file structure operation section 211 issues a Write command to the optical disk drive apparatus 204 for each of the data portions (step S607).

5 [0133] The data write control section 235 records the data portion transmitted from the system control apparatus 200 in a predetermined sector, and when a defective sector is detected, the defective sector operation section 234 performs a replacement operation for the defective sector.

10 [0134] When the recording operation for the data portions is completed, the remaining spare amount reporting section 231 reports Status information indicating the execution result of the Write command to the system control apparatus 200 (step S608). The Status information includes information indicating the number of defective sectors which have occurred during the data transmission.

15 [0135] The command status operation section 216 receives the Status information from the optical disk drive apparatus 204, and stores the information indicating the number of defective sectors which have occurred during the data transmission in the spare area information memory 224. The spare area extension determination section 215 determines whether or not any defective sector has occurred during the data transmission based on the information stored in the spare area information memory 224. If any defective sector has occurred, the spare area extension determination section 215 determines that the first spare area 102 should be extended by the number of defective sectors (step S609).

20 [0136] The determination operation illustrated in Figure 6C has a feature that it is possible to effectively utilize the area of the optical disk that is available for recording. This is because the spare area can be extended each time a defective sector is detected, whereby the size of the area which is allocated as a spare area can be reduced.

25 [0137] In the above-described determination operation, the report by the remaining spare amount reporting section 231 of the remaining amount of the spare area to the system control apparatus 200 may be done in any form. For example, the remaining amount of the spare area may be represented in the form of flags or in the form of a remaining amount value.

30 [0138] Next, a method for extending the first spare area 102 and the second spare area 108 will now be described in detail with reference to Figures 1, 2 and 7.

35 [0139] Figure 7 is a protocol chart illustrating a procedure of an operation of extending the first spare area 102 and a second spare area 108. This operation is performed by the optical disk drive apparatus 204 and the system control apparatus 200.

40 [0140] When it is determined by the spare area extension determination section 215 that the first spare area 102 (or the second spare area 108) should be extended, the spare extension area detection section 212 determines the area to be allocated as an additional spare

area based on the second spare area location information **143** stored in the file structure memory **221** (step S701).

[0141] When allocating the second spare area **108** for the first time, the second spare area **108** may be allocated in any area in the logical volume space **100b**. However, when contiguous data of a large file size such as audio video data (AV data) is recorded on the optical disk, it is necessary to allocate a larger contiguous unallocated area **107**. Therefore, when allocating the second spare area **108** for the first time, the second spare area **108** is desirably allocated starting from the end of the logical volume space **100a**.

[0142] The spare sectors included in the second spare area **108** are used in an order such that spare sectors assigned with larger LSNs are used before those assigned with smaller LSNs. In other words, the defective sectors are replaced by the spare sectors in descending order of the LSNs assigned to the spare sectors.

[0143] When the second spare area **108** is extended, the second spare area **108** is extended in a direction along which the LSN decreases. When the second spare area **108** is extended, the area allocated as an additional spare area may be an area contiguous with the second spare area **108** or an area separated from the second spare area **108**.

[0144] The file structure operation section **211** determines whether or not the area to be allocated as an additional spare area is unallocated based on the space bit map information stored in the bit map memory **222** (step S702). If the area is unallocated, the process proceeds to step S704, and if not, the process proceeds to step S704 via step S703. This is because when the area to be allocated as an additional spare area is not unallocated (i.e., when data is already recorded in the area), it is necessary to move the data to another location before the area can be used as an additional spare area.

[0145] The file moving operation section **213** performs a file moving operation (step S703). In particular, the file moving operation section **213** examines the file structure of all the files on the optical disk to determine the data recorded in the area. Then, the file moving operation section **213** uses the space bit map information to search for an area to which it is possible to move the data which has already been recorded in the area to be allocated as an additional spare area, move the data according to the attribute of the data, and update the information of the file structure managing the moved data (step S703). In this way, an additional spare area is allocated.

[0146] Although not shown in Figure 7, the spare extension area allocation section **214** instructs the optical disk drive apparatus **204** to examine whether or not there is any defective sector in the area to be allocated as an additional spare area. When there is any defective sector in the area, the spare extension area allocation section **214** instructs the spare extension area detection

section **212** to increase the size of the additional area, and returns the control of the process to step S701. Thus, the process is performed again from step S701.

[0147] When there is no defective sector in the area to be allocated as an additional spare area, the spare extension area allocation section **214** issues a Write command and transmits data for updating the file entry area **116** stored in the file structure memory **221** (step S704).

[0148] The data write control section **235** records the data transmitted from the system control apparatus **200** in the file entry area **116** (step S705). As a result, the second spare area location information **143** recorded in the file entry area **116** is updated.

[0149] The spare extension area issue section **217** issues an instruction to extend the spare area by using an Alloc Spare command. Specifically, the spare extension area issue section **217** issues an Alloc Spare command and transmits data for updating the second spare area location information **133** to the optical disk drive apparatus **204** (step S706).

[0150] The data write control section **235** updates the second spare area location information **133** stored in the defect management information memory **241** based on the data transmitted from the system control apparatus **200** (step S707).

[0151] Thus, when any data is recorded in the area to be allocated as an additional spare area, the data recorded in the area to be allocated as an additional spare area is moved to another area by analyzing the information of the file structure. In this way, the spare area can be extended even when data has been recorded in an area into which a spare area is to be extended.

[0152] When there is any defective sector in an area to be allocated as an additional spare area, the size of the additional spare area is increased according to the number of the defective sectors. Thus, it is possible to reliably ensure a spare area of a required size.

[0153] Next, countermeasures which can be taken when the second spare area location information **143** managed by the system control apparatus **200** and the second spare area location information **133** managed by the optical disk drive apparatus **204** are not consistent with each other and a method for recovering the inconsistency between the information **143** and **133** will be described.

[0154] In Figure 1, it is assumed that sector a (sector **117**) in the data area **105** has been detected as a defective sector, and the sector **117** has been replaced by the #4 spare sector **122**. In such a case, the #4 spare sector **122** is specified by two LSNs. The first LSN is one of the LSNs which are sequentially assigned in the volume space **100a** starting from the beginning of the volume space **100a** (herein, LSN=n). The second LSN is the LSN which is assigned to the replaced defective sector **117** (herein, LSN=m).

[0155] When the second spare area location information **143** managed by the system control apparatus **200**

and the second spare area location information **133** managed by the optical disk drive apparatus **204** are not consistent with each other, the system control apparatus **200** may possibly issue a Write command to the sector whose LSN is n. When the recording operation is performed, the data recorded in the #4 spare sector **122** is overwritten. As a result, data of the file named "File-a" is destroyed.

[0156] In order to avoid the fatal incident of destroying the data of a file, the optical disk drive apparatus **204** recognizes the sectors included in the second spare area **108** by referencing the second spare area location information **133**. When it is requested to record data in a sector included in the second spare area **108**, the optical disk drive apparatus **204** reports to the system control apparatus **200** error information indicating prohibition of a recording request to the second spare area **108**, without performing a recording operation corresponding to the request. In this way, it is possible to prevent data of a file from being destroyed due to the inconsistency between the second spare area location information **133** and the second spare area location information **143**.

[0157] When the system control apparatus **200** receives the error information, the system control apparatus **200** preferably performs an operation of making the second spare area location information **133** consistent with the second spare area location information **143**. For example, as described above in the description of the format operation, the system control apparatus **200** may obtain the second spare area location information **133** based on the information reproduced from the defect management information area **101**, and update the second spare area location information **143** recorded in the file entry area **116** based on the location information **133**, while updating the space bit map stored in the bit map memory **222** based on the location information **143**.

[0158] Before updating the second spare area location information **143**, it is preferred to confirm that an area which is newly registered in the file entry as the second spare area **108** is not being used for any purpose other than a spare area, as described above in the description of the operation of extending a spare area. Such confirmation can be done by examining all the file structures.

[0159] The above-described example where the location information **133** and **143** are not consistent with each other is an exemplary case where the size of the second spare area **108** recorded in the defect management information area **101** is greater than the size of the second spare area **108** recorded in the file entry area **116**.

[0160] It is possible to detect the inconsistency between the location information **133** and **143** and to make the location information **133** and **143** consistent with each other also when the size of the second spare area **108** recorded in the defect management information area **101** is less than the size of the second spare area **108** recorded in the file entry area **116**.

[0161] For example, as a start-up operation for the system control apparatus **200**, the system control apparatus **200** may obtain the location information **133** based on the data reproduced from the basic file structure area **104**, while obtaining the location information **143** by making an inquiry for the spare area information. By comparing the location information **133** and the location information **143** with each other, it is possible to detect the inconsistency between the location information **133** and **143**.

[0162] When the inconsistency between the location information **133** and **143** is detected, the system control apparatus **200** instructs the optical disk drive apparatus **204** to correctly update the second spare area location information by using an Alloc Spare command.

(Embodiment 2)

[0163] In Embodiment 2, an example where the second spare area **108** is allocated outside the volume space **100a** will be described.

[0164] In Embodiment 2, an information recording/reproduction system **1b** is used. The configuration of the information recording/reproduction system **1b** is the same as that of the information recording/reproduction system 1a illustrated in Figure 2, and thus will not be described below.

[0165] Each of the system control apparatus **200** and the optical disk drive apparatus **204** is connected to the I/O bus **203** via a SCSI or ATAPI interface. Commands and data are exchanged between the system control apparatus **200** and the optical disk drive apparatus **204**.

[0166] The system control apparatus **200** and the optical disk drive apparatus **204** may be an integrally-formed single apparatus. In such a case, the interface between the system control apparatus **200** and the optical disk drive apparatus **204** may be a simplified dedicated interface.

[0167] Figure 8 is a diagram illustrating a structure of the data recording area **100** of an optical disk according to an embodiment of the present invention. In Figure 8, reference numeral **181** denotes the state of the optical disk after the format operation, reference numeral **182** denotes the state of the optical disk after a data write operation of recording a file named "File-a" on the optical disk, and reference numeral **183** denotes the state of the optical disk after a data write operation of recording a file named "File-b" on the optical disk.

[0168] Figure 9 is a protocol chart illustrating a data write operation for recording a file on an optical disk.

[0169] The data write operation illustrated in Figure 9 includes: step S807 of calculating the status of consumption of a spare area; step S809 of determining additional allocation of a spare area based on the calculated status of consumption; step S811 of making a part of the volume space available as a spare area; and step S817 of registering the area made available as a spare area. These steps are the same as those in the data

write operation described in Embodiment 1.

[0170] A data write operation of recording a file (File-a) on the optical disk when the optical disk is in the state denoted by reference numeral **181** in Figure **8** will now be described. Through this data write operation, the state of the optical disk transitions from the state denoted by reference numeral **181** in Figure **8** to the state denoted by reference numeral **182** in Figure **8**. Through this data write operation, a second spare area **153** is newly allocated. The state of the optical disk denoted by reference numeral **181** is the same as that illustrated in Figure **4**.

[0171] When the optical disk is inserted into the optical disk drive apparatus **204**, as a start-up operation for the optical disk drive apparatus **204**, the remaining spare area amount detection section **233** obtains information which indicates the status of consumption of the first spare area **102** (step S801).

[0172] For example, the remaining spare area amount detection section **233** may obtain information indicating the status of consumption of the first spare area **102** by referencing the spare area full flag **132**. The first full flag **138** being set indicates that all of the spare sectors in the first spare area **102** are used (i.e., no spare sector is available for replacement in the first spare area **102**).

[0173] In the first spare area **102**, the spare sectors are sequentially used starting from the spare sector that is assigned the largest physical sector number. In other words, the defective sectors are replaced by the spare sectors in descending order of the physical sector numbers assigned to the spare sectors. Such an order in which the spare sectors are used is also used in the second spare area **108**.

[0174] The remaining spare area amount detection section **233** may alternatively retrieve one of the replacement entries recorded in the defect management information area **101** that has the smallest location information (e.g., the physical sector number) of a spare sector so as to obtain the information indicating the status of consumption of the first spare area **102** based on the location information of the spare sector in the retrieved replacement entry. Thus, the remaining spare area amount detection section **233** can know the amount of spare sector available in the first spare area **102** based on the location information of the spare sector in the retrieved replacement entry and the size of the first spare area **102**. In the example illustrated in Figure **8**, the size of the first spare area **102** is predetermined. Therefore, the remaining spare area amount detection section **233** can know the amount of spare sectors available in the first spare area **102** based on the location information of the spare sector in the retrieved replacement entry.

[0175] Thus, the information indicating the status of consumption of the first spare area **102** may be either the first full flag **138** or the amount of spare sector available in the first spare area **102**.

[0176] As a start-up operation for the system control apparatus **200**, the file structure operation section **211** issues a Read command to the optical disk drive apparatus **204** (step S802).

[0177] The data read control section **236** reproduces data recorded in the volume structure area **103** and the basic file structure area **104** according to the address specified by the Read command, and returns the reproduced data to the system control apparatus **200** (step S803).

[0178] The file structure operation section **211** receives the data reproduced from the optical disk drive apparatus **204**, and analyzes the basic file structure based on the reproduced data (step S802).

[0179] The file structure operation section **211** issues a Write command and transmits data of the file (File-a) to the optical disk drive apparatus **204** (step S804).

[0180] The data write control section **235** records the data transmitted from the system control apparatus **200** in the data area **105** and the file structure area **106** (step S805).

[0181] When any defective sector is detected in the data write operation in step S805, the defective sector operation section **234** performs a replacement operation of replacing the defective sector by a spare sector in the first spare area **102** (step S806).

[0182] The remaining spare area amount detection section **233** obtains information indicating the status of consumption of the first spare area **102** based on the information of the defect management information memory **241** which has been updated in step S806 (step S807).

[0183] When the first spare area **102** has been exhausted, the remaining spare amount reporting section **231** notifies the system control apparatus **200** of the information indicating that the first spare area **102** has been exhausted (step S810). Such a notification can be made by, for example, by returning to the system control apparatus **200** "Recovered Error" as Status information to the Write command transmitted in step S804.

[0184] The spare area extension determination section **215** recognizes the exhaustion of the first spare area **102** via the command status operation section **216**, and determines to allocate the second spare area **153** in an area in the outermost periphery of the data recording area by reducing the volume space **100a** (step S809).

[0185] Since the second spare area is allocated in an area in the data recording area **100** whose PSN is largest, the second spare area location information **133** is represented only by the PSN of the first sector included in the second spare area **108**, for example.

[0186] The spare extension area allocation section **214** instructs the optical disk drive apparatus **204** to update the volume structure areas **103** and **109** and the basic file structure area **104** by using a Read command and a Write command in order to allocate an area for allocating the second spare area **153** in the area on the

outer periphery side following the volume space **100a** by reducing the volume space **100a** (step S811).

[0187] The data write control section **235** and the data read control section **236** update the volume structure areas **103** and **109** and the basic file structure area **104** according to these commands (step S812).

[0188] The details of the update operation illustrated in steps S811 and S812 will be described later with reference to Figure **11**.

[0189] The spare extension area issue section **217** instructs the optical disk drive apparatus **204** to register the newly-allocated area as the second spare area **153** by using an Alloc Spare command (step S813). A Format Unit command may alternatively be used instead of an Alloc Spare command.

[0190] The spare area allocation section **232** recognizes that a second spare area has not been allocated by using the second spare area location information **133** stored in the defect management information memory **241**, updates the second spare area location information **133** stored in the defect management information memory **241** so as to newly allocate the second spare area **153** based on an Alloc Spare command (or a Format Unit command), and resets the second full flag **139** for the second spare area **153** (step S814). Since the second spare area **153** is allocated outside the volume space, the sectors in the second spare area **153** do not have LSNs.

[0191] The defective sector operation section **234** records the updated defect management information **130** stored in the defect management information memory **241** in the defect management information area **101** (step S817). Such recording is performed immediately after step S813 or when there is no data recording instruction from the system control apparatus **200** for a predetermined period of time (e.g., 5 seconds).

[0192] Thus, the optical disk drive apparatus **204** and the system control apparatus **200** cooperate with each other to additionally allocate the second spare area **153**, whereby it is possible to increase the reliability of data recording.

[0193] The second spare area **153** may be allocated in an area separated from the first spare area **102** or in an area contiguous with the first spare area **102**.

[0194] For example, the second spare area **153** is allocated in an area including a sector which is assigned a physical sector number that is larger than that of any sector in the first spare area **102**. When the second spare area **153** includes a plurality of spare sectors, the defective sector is replaced by a corresponding one of the spare sectors in descending order of the physical sector numbers assigned to the spare sectors.

[0195] Moreover, as indicated by reference numeral **182** in Figure **8**, the volume space **100a** is re-configured to include the volume structure area **103**, the basic file structure area **104**, the data area (File-a) **105**, the file structure area (File-a) **106**, an unallocated area **151** and a volume structure area **152**, while holding the files that

have already been recorded on the optical disk.

[0196] In this way, the volume space **100a** is re-configured so that the second spare area **153** is allocated outside the volume space **100a**. This eliminates the need for the operation for avoiding the inconsistency between the second spare area location information **133** recorded in the defect management information area **101** and the second spare area location information **143** recorded in the file entry area **116**, as that described in Embodiment 1 above.

[0197] Moreover, in Embodiment 2, it is not necessary to record the location information of the second spare area in the basic file structure area **104**. This eliminates the need to provide a special data structure for the file system, whereby when reusing an optical disk on which a second spare area has once been allocated, it is possible to reuse the optical disk, after a logical format, not only for the file system described in the present embodiment but also for a more generally-used FAT file system which is used in, e.g., MS-DOS.

[0198] The size of the second spare area **153** may be determined according to the status of consumption of the first spare area **102**. For example, if in step S810 the remaining spare amount reporting section **231** reports the exhaustion of the first spare area **102** to the system control apparatus **200** when the size of the spare sector in the first spare area **102** available for replacement has decreased to be 1 MB or less, then the second spare area **153** may be allocated by blocks of 1 MB.

[0199] When ECC (Error Correction Code) is arranged by blocks of 16 sectors, one ECC block includes 16 sectors. Then, the replacement of defective sectors may be performed by ECC blocks, rather than by blocks of sectors. By performing the replacement operation by ECC blocks, it is no longer necessary to re-calculate ECCs, whereby the recording/reproduction system can be simplified.

[0200] Preferably, the smallest unit by which the second spare area can be extended is predetermined. For example, it may be determined to extend the second spare area by blocks of 32 ECC blocks (1 MB). In such a case, as compared to a case where the spare area is extended by blocks of 2 to 3 sectors, it is possible to reduce the frequency of exhaustion of spare area. Moreover, by extending the second spare area by ECC blocks, it is possible to facilitate the replacement of defective sectors by ECC blocks.

[0201] The descriptors defined in the ECMA167 standard which are recorded in the volume structure area **103**, the basic file structure area **104**, the file structure area (File-a) **106** and the volume structure area **152** may be recorded on the optical disk in a dispersed arrangement.

[0202] A data write operation of recording a file (File-b) on the optical disk when the optical disk is in the state denoted by reference numeral **182** in Figure **8** will now be described. Through this data write operation, the state of the optical disk transitions from the state denot-

ed by reference numeral **182** in Figure 8 to the state denoted by reference numeral **183** in Figure 8. Through this data write operation, an additional spare area is allocated in an area which is contiguous with the second spare area **153** which has already been allocated. As a result, a second spare area **158** is allocated which is obtained by extending the second spare area **153**.

[0203] Thus, the second spare area **153** can be extended in a direction along which the physical sector number decreases.

[0204] The data write operation of recording the file (File-b) on the optical disk is also performed according to steps S801-S817 illustrated in Figure 9.

[0205] The operations of steps S801-S803 are the same as those described above, and thus will not be described below.

[0206] The file structure operation section **211** issues a Write command and transmits data of the file (File-b) to the optical disk drive apparatus **204** (step S804).

[0207] The data write control section **235** records the data transmitted from the system control apparatus **200** in a data area **154** and a file structure area **155** (step S805).

[0208] When any defective sector is detected in the data write operation in step S805, the defective sector operation section **234** performs a replacement operation for replacing the defective sector by the spare sectors in the second spare area **153** (step S806). A replacement entry indicating that the defective sector has been replaced by a spare sector is generated, and the replacement entry is stored in the defect management information memory **241** before it is recorded in the defect management information area **101**.

[0209] If all of the spare sectors in the second spare area **153** have been consumed, the defective sector operation section **234** sets the second full flag **139** of the spare area full flag **132**.

[0210] The remaining spare area amount detection section **233** obtains information indicating the status of consumption of the second spare area **153** (step S807). The method for obtaining the information indicating the status of consumption of the second spare area **153** is similar to the above-described method for obtaining the information indicating the status of consumption of the first spare area **102**.

[0211] When the second spare area **153** is exhausted, the remaining spare amount reporting section **231** notifies the system control apparatus **200** of the information indicating that the second spare area **153** has been exhausted (step S810).

[0212] The spare area extension determination section **215** recognizes the exhaustion of the second spare area **153** via the command status operation section **216**, and determines to newly allocate an additional spare area in an area which is contiguous with the second spare area **153** (step S809).

[0213] The spare extension area allocation section **214** instructs the optical disk drive apparatus **204** to up-

date the volume structure areas **103** and **152** and the basic file structure area **104** by using a Read command and a Write command in order to allocate an area for allocating the additional spare area by reducing the volume space **100a** (step S811).

[0214] The data write control section **235** and the data read control section **236** update the volume structure areas **103** and **152** and the basic file structure area **104** according to these commands (step S812).

[0215] The spare extension area issue section **217** instructs the optical disk drive apparatus **204** to register the newly-allocated area and the second spare area **153** as the new second spare area **158** (step S813).

[0216] The spare area allocation section **232** recognizes that the second spare area **153** has been allocated by using the second spare area location information **133** stored in the defect management information memory **241**, and checks the second full flag **139**. Then, the spare area allocation section **232** updates the second spare area location information **133** stored in the defect management information memory **241** so as to extend the second spare area in a direction along which the physical sector number decreases, and when the second full flag **139** for the second spare area **153** is set, resets the second full flag **139** (step S814). Thus, it is possible to use a spare sector available for replacement in the second spare area **158**.

[0217] The defective sector operation section **234** records the updated defect management information **130** stored in the defect management information memory **241** in the defect management information area **101** (step S817). Such recording is performed when there is no data recording instruction from the system control apparatus **200** for a predetermined period of time (e.g., 5 seconds).

[0218] Thus, by the cooperation of the optical disk drive apparatus **204** and the system control apparatus **200**, it is possible to extend the second spare area according to the frequency of occurrence of defective sectors.

[0219] Figure 10 is a protocol chart illustrating a procedure of an operation which is performed when an optical disk is inserted into an optical disk drive apparatus. In this procedure, the status of consumption of the spare area is examined upon insertion of the optical disk. As a result, whether or not it is necessary to allocate an additional spare area is determined according to the status of consumption of the spare area.

[0220] In the following description made in connection with Figure 10, the term "spare area" refers to the "first spare area **102**", the "second spare area **153**" or the "second spare area **158**" illustrated in Figure 8.

[0221] The file structure operation section **211** issues a Get Spare Info command to the optical disk drive apparatus **204** in order to inquire as to the status of consumption of the spare area (step S821). The file structure operation section **211** may alternatively use a Read DVD Structure command instead of a Get Spare Info

command.

[0222] The remaining spare area amount detection section **233** obtains information indicating the status of consumption of the spare area (step S807). The information indicating the status of consumption of the spare area includes, for example, information indicating the size of area in the spare area that is available for replacement.

[0223] The remaining spare amount reporting section **231** reports the information indicating the status of consumption of the spare area to the system control apparatus **200** (step S810).

[0224] The spare area extension determination section **215** determines whether or not to allocate an additional spare area according to the status of consumption of the spare area. For example, when the size of area in the spare area that is available for replacement is less than or equal to a predetermined size (e.g., 1 MB), the spare area extension determination section **215** determines to newly allocate an additional spare area (step S809).

[0225] The operations of steps S811-S817 illustrated in Figure **10** are the same as those of steps S811-S817 illustrated in Figure **9**, and thus will not be described below.

[0226] Thus, by the cooperation of the optical disk drive apparatus **204** and the system control apparatus **200**, it is possible, before recording data, to allocate a spare area having an optimal size according to the status of consumption of the spare area.

[0227] An operation of updating the volume structure areas **103** and **109** and the basic file structure area **104** will now be described in detail with reference to Figure **11**. The update operation is performed by the spare extension area allocation section **214**. In Figure **11**, each reference numeral that starts with "S" denotes a step in the update operation.

[0228] Figure **11** illustrates, as indicated by reference numerals **191** and **192**, the data structure of the optical disk in the state denoted by reference numerals **181** and **182** in Figure **8**, respectively, in greater detail, i.e., on the descriptor level, which is defined in the ECMA167 standard.

[0229] The volume structure area **103** is arranged along the inner periphery of the volume space **100a**. A main volume descriptor sequence **161** for defining the volume space **100a** as a logical space, a logical volume integrity descriptor **162** having integrity information of the logical volume space **100a**, an anchor volume descriptor pointer indicating the location at which to start reading out the volume structure, and a file set descriptor **164** are recorded in the volume structure area **103**.

[0230] While a file set descriptor is defined as a file structure according to ECMA167, in the example illustrated in Figure **11**, a file set descriptor is defined as a volume structure for the purpose of discussion.

[0231] The volume structure area **109** is arranged in the outermost periphery of the volume space **100a**. An

anchor volume descriptor pointer **165** and a reserve volume descriptor sequence **156** are recorded in the volume structure area **109**.

[0232] The basic file structure area **104** includes the space bit map area **113**, the file entry area **114**, and the root directory area **115**. A space bit map for managing unallocated areas in the logical volume space **100b** is recorded in the space bit map area **113**. The file entry of the root directory is recorded in the file entry area **114**. Information of the root directory is recorded in the root directory area **115**.

[0233] The spare extension area allocation section **214** retrieves the size and the location of the unallocated area **107** based on the information reproduced from the space bit map area **113**.

[0234] When the unallocated area **107** that is larger than the size of the additional spare area to be allocated as the second spare area **153** exists at the end of the logical volume space **100b** (i.e., a portion along the outermost periphery of the logical volume space **100b**), the spare extension area allocation section **214** updates the space bit map area **113** so as to reduce the logical volume space **100b** by the size of the additional spare area (step S101).

[0235] When there is no unallocated area **107** that is larger than the size of the additional spare area, a file moving operation (step S703 in Figure **7**) is performed. As a result, data of a file which has already been recorded is moved to another area.

[0236] The spare extension area allocation section **214** updates and moves the reserve volume descriptor sequence **156** and the anchor volume descriptor pointer **165** so that the second spare area **153** can be allocated (steps S102 and S103).

[0237] The spare extension area allocation section **214** updates the main volume descriptor sequence **161** and the logical volume integrity descriptor **162** in order to define a reduced logical volume space (steps S104 and S105).

[0238] Finally, the spare extension area allocation section **214** updates an anchor volume descriptor pointer **163** in order to activate the updated volume structure and the updated file structure (step S106).

[0239] Thus, by making a part of the volume space **100a** available, it is possible to allocate an area in which the second spare area **153** is allocated.

[0240] In the information recording medium of the present invention, the volume space in which user data can be recorded is configured so that the second spare area can be additionally allocated. Thus, it is possible to dynamically extend the spare area according to the frequency of occurrence of defective sectors. As a result, it is possible to ensure the reliability of data recording without performing an initialization operation or a reformat operation even when there occurs more defective sectors than expected.

[0241] Since the spare area can be extended according to the frequency of occurrence of defective sectors,

it is possible to maximize the amount of user data which can be recorded in the logical volume space.

[0242] When data is recorded in an area to be allocated as an additional spare area, the additional spare area can be allocated after moving the data to another area. Thus, it is possible to increase the freedom in the area where an additional spare area can be allocated.

Claims

1. An information recording medium including a plurality of sectors, the information recording medium comprising a data recording area, the data recording area including:

a first spare area (102) having a replacement area including a spare sector (110-112) for replacing a defective area including a defective sector among the plurality of sectors; a defect management information area (101) in which defect management information for managing the replacement of the defective area including the defective sector by the replacement area including the spare sector is recorded; and a volume space (100a) in which user data can be recorded, wherein:

each of the sectors in the data recording area is assigned a physical sector number; in the data recording area, a second spare area (108; 153; 158) having a replacement area including a spare sector (120-122) for replacing a defective area including a defective sector among the plurality of sectors can be allocated in an area including a sector having a physical sector number which is larger than a physical sector number assigned to the spare sector (110-112) in the first spare area, and the second spare area (108; 153; 158) can be extended in a direction along which the physical sector number decreases; and the defect management information area (101) has an area for recording location information which indicates allocation of the second spare area (108; 153; 158).

2. An information recording method for recording information on an information recording medium including a plurality of sectors, the information recording medium comprising a data recording area, the data recording area including:

a first spare area (102) having a replacement area including a spare sector (110-112) for replacing a defective area including a defective sector among the plurality of sectors;

a defect management information area (101) in which defect management information for managing the replacement of the defective area including the defective sector by the replacement area including the spare sector is recorded; and a volume space (100a) in which user data can be recorded, wherein:

in the data recording area, a second spare area (108; 153; 158) having a replacement area including a spare sector (120-122) for replacing a defective area including a defective sector among the plurality of sectors can be extended; and each of the spare sector in the first spare area (102) and the spare sector in the second spare area (108; 153; 158) is assigned a physical sector number, and the physical sector number assigned to the spare sector in the first spare area is smaller than the physical sector number assigned to the spare sector in the second spare area, the information recording method comprising the steps of:

- (a) obtaining information which indicates a status of consumption of the second spare area;
- (b) determining whether or not to extend, in the data recording area, the second spare area having a replacement area including a spare sector for replacing a defective area including a defective sector among the plurality of sectors according to the information which indicates the status of consumption of the second spare area; and
- (c) when the second spare area is extended, extending the second spare area in a direction along which the physical sector number decreases.

3. An information recording/reproduction system for an information recording medium including a plurality of sectors, the information recording medium comprising a data recording area, the data recording area including:

a first spare area (102) having a replacement area including a spare sector (110-112) for replacing a defective area including a defective sector among the plurality of sectors; a defect management information area (101) in which defect management information for managing the replacement of the defective area including the defective sector by the replacement area including, the spare sector is recorded; and

a volume space (100a) in which user data can be recorded, wherein:

in the data recording area, a second spare area (108; 153; 158) having a replacement area including a spare sector (120-122) for replacing a defective area including a defective sector among the plurality of sectors can be extended; and
 each of the spare sector in the first spare area (102) and the spare sector in the second spare area (108; 153; 158) is assigned a physical sector number, and the physical sector number assigned to the spare sector in the first spare area is smaller than the physical sector number assigned to the spare sector in the second spare area, the information recording/reproduction system comprising:
 a remaining spare area amount detection section (233) for obtaining information which indicates a status of consumption of the second spare area;
 a spare area extension determination section (215) for determining whether or not to extend, in the data recording area, the second spare area having a replacement area including a spare sector for replacing a defective area including a defective sector among the plurality of sectors according to the information which indicates the status of consumption of the second spare area; and
 a spare extension area allocation section (214, 232) for, when the second spare area is extended, extending the second spare area in a direction along which the physical sector number decreases.

Patentansprüche

1. Informationsaufzeichnungsmedium mit einer Vielzahl von Sektoren, wobei das Informationsaufzeichnungsmedium einen Datenaufzeichnungsbereich aufweist und der Datenaufzeichnungsbereich enthält:

einen ersten Ersatz- bzw. Vorrats- bzw. Reservebereich (102) mit einem Austauschbereich mit einem Ersatz- bzw. Vorrats- bzw. Reserve-Sektor (110-112) für den Austausch eines defekten Bereiches einschließlich eines defekten Sektors aus der Vielzahl von Sektoren;
 einen Defekt-Verwaltungs-Informationsbereich (101), in dem Defekt-Verwaltungs-Informationen für die Verwaltung des Austausches des defekten Bereiches einschließlich des defekten

Sektors durch den Austauschbereich einschließlich des Ersatz-Sektors aufgezeichnet werden; und

einen Massen-Bereich bzw. -Raum (100a), in dem Benutzer-Daten aufgezeichnet werden können, wobei:

jedem der Sektoren in dem Datenaufzeichnungsbereich eine Nummer eines physikalischen Sektors zugeordnet ist;
 in dem Datenaufzeichnungsbereich ein zweiter Ersatz- bzw. Vorrats- bzw. Reserve-Bereich (108; 153; 158) mit einem Austauschbereich einschließlich eines Ersatz- bzw. Vorrats- bzw. Reserve-Sektors (120-122) für den Austausch eines defekten Bereiches einschließlich eines defekten Sektors aus der Vielzahl von Sektoren in einem Bereich mit einem Sektor mit einer Nummer für einen physikalischen Sektor zugeordnet werden kann, die größer als die Nummer eines physikalischen Sektors ist, die dem Ersatz-Sektor (110-112) in dem ersten Ersatzbereich zugeordnet ist, und der zweite Ersatzbereich (108; 153; 158) in eine Richtung erweitert werden kann, längs der die Nummer des physikalischen Sektors abnimmt; und
 der Defekt-Verwaltungs-Informationsbereich (101) einen Bereich für die Aufzeichnung von Positions-Informationen hat, die die Zuordnung des zweiten Ersatzbereiches (108; 153; 158) angeben.

2. Informationsaufzeichnungsverfahren für die Aufzeichnung von Informationen auf einem Informationsaufzeichnungsmedium mit einer Vielzahl von Sektoren, wobei das Informationsaufzeichnungsmedium einen Datenaufzeichnungsbereich aufweist und der Datenaufzeichnungsbereich enthält:

einen ersten Ersatz- bzw. Vorrats- bzw. Reserve-Bereich (102) mit einem Austauschbereich mit einem Ersatz- bzw. Reserve- bzw. Vorrats-Sektor (110-112) für den Austausch eines defekten Bereiches einschließlich eines defekten Sektors aus der Vielzahl von Sektoren;
 einen Defekt-Verwaltungs-Informationsbereich (101), in dem Defekt-Verwaltungs-Informationen für die Verwaltung des Austausches des defekten Bereiches einschließlich des defekten Sektors durch den Austauschbereich einschließlich des Ersatzsektors aufgezeichnet werden; und
 einen Massen-Raum bzw. -Bereich, in dem Benutzerdaten aufgezeichnet werden können, wobei:

in dem Datenaufzeichnungsbereich ein zweiter Ersatz- bzw. Vorrats- bzw. Reserve-Bereich (108; 153; 158) mit einem Austauschbereich einschließlich eines Ersatz- bzw. Vorrats- bzw. Reserve-Sektors (120-122) für den Austausch eines defekten Bereiches einschließlich eines defekten Sektors aus der Vielzahl der Sektoren erweitert werden kann; und
 jedem der Ersatz-Sektoren in dem ersten Ersatz-Bereich (102) und dem Ersatz-Sektor in dem zweiten Ersatz-Bereich (108; 153; 158) ist eine Nummer eines physikalischen Sektors zugeordnet, und die Nummer des physikalischen Sektors, die dem Ersatz-Sektor in dem ersten Ersatz-Bereich zugeordnet ist, ist kleiner als die Nummer des physikalischen Sektors, die dem Ersatz-Sektor in dem zweiten Ersatz-Bereich zugeordnet ist, wobei das Informationsaufzeichnungsverfahren die Schritte aufweist:

- (a) Erhalten von Informationen, die einen Verbrauchsstatus des zweiten Ersatz-Bereiches angeben;
- (b) Feststellen, ob man in dem Datenaufzeichnungsbereich den zweiten Ersatz-Bereich mit einem Austauschbereich mit einem Ersatz-Sektor für den Austausch eines defekten Bereiches einschließlich eines defekten Sektors aus der Vielzahl von Sektoren gemäß den Informationen, die den Verbrauchsstatus des zweiten Ersatz-Bereiches angeben, erweitern soll oder nicht; und
- (c) Erweitern des zweiten Ersatz-Bereiches in einer Richtung, längs der die Nummer des physikalischen Sektors abnimmt, wenn der zweite Ersatz-Bereich erweitert wird.

3. Informationsaufzeichnungs-/Wiedergabesystem für ein Informationsaufzeichnungsmedium mit einer Vielzahl von Sektoren, wobei das Informationsaufzeichnungsmedium einen Datenaufzeichnungsbereich aufweist und der Datenaufzeichnungsbereich enthält:

einen ersten Ersatz- bzw. Reserve- bzw. Vorratsbereich (102) mit einem Austauschbereich mit einem Ersatz- bzw. Vorrats- bzw. Reserve-Sektor (110-112) für den Austausch eines defekten Bereiches einschließlich eines defekten Sektors aus der Vielzahl von Sektoren; einen Defekt-Verwaltungs-Informationsbereich (101), in dem Defekt-Verwaltungs-Info-

nen für die Verwaltung des Austausches des defekten Bereiches einschließlich des defekten Sektors durch den Austauschbereich einschließlich des Ersatz-Sektors aufgezeichnet werden; und einen Massen-Raum bzw. -Bereich (100a), in dem Benutzerdaten aufgezeichnet werden können, wobei:

in dem Datenaufzeichnungsbereich ein zweiter Ersatz- bzw. Vorrats- bzw. Reserve-Bereich (108; 153; 158) mit einem Austauschbereich einschließlich eines Ersatz- bzw. Vorrats- bzw. Reserve-Sektors (120-122) für den Austausch eines defekten Bereiches einschließlich eines defekten Sektors aus der Vielzahl von Sektoren erweitert werden kann; und sowohl dem Ersatz-Sektor in dem ersten Ersatz-Bereich (102) als auch dem Ersatz-Sektor in dem zweiten Ersatz-Bereich (108; 153; 158) eine Nummer eines physikalischen Sektors zugeordnet ist und die Nummer des physikalischen Sektors, die dem Ersatz-Sektor in dem ersten Ersatz-Bereich zugeordnet ist, ist kleiner als die Nummer des physikalischen Sektors, die dem Ersatz-Sektor in dem zweiten Ersatz-Bereich zugeordnet ist, wobei das Informationsaufzeichnungs-/Wiedergabesystem aufweist:

- eine Sektion (233) für die Feststellung der verbleibenden Ersatzbereich-Größe zum Erhalt von Informationen, die den Verbrauchsstatus des zweiten Ersatz-Bereiches angeben;
- eine Sektion (215) zur Feststellung der Erweiterung des Ersatz-Bereiches, um festzulegen, ob in dem Datenaufzeichnungsbereich der zweite Ersatz-Bereich mit einem Austauschbereich einschließlich eines Ersatz-Sektors für den Austausch eines defekten Bereiches einschließlich eines defekten Sektors aus der Vielzahl der Sektoren gemäß den Informationen erweitert werden sollen oder nicht, die den Verbrauchsstatus des zweiten Ersatz-Bereiches angeben; und
- eine Sektion (214, 232) für die Zuordnung einer Erweiterung für den Ersatz-Bereich, wenn der zweite Ersatz-Bereich erweitert wird, wobei sich der zweite Ersatz-Bereich in eine Richtung erweitert, längs der die Nummer des physikalischen Sektors abnimmt.

Revendications

1. Support d'enregistrement d'informations comprenant une pluralité de secteurs, le support d'enregistrement d'informations comprenant une zone d'enregistrement de données, la zone d'enregistrement de données incluant :

une première zone de réserve (102) comportant une zone de remplacement incluant un secteur de réserve (110 à 112) destinée à remplacer une zone défectueuse incluant un secteur défectueux parmi la pluralité de secteurs, une zone d'informations de gestion de défauts (101) dans laquelle des informations de gestion de défauts destinées à gérer le remplacement de la zone défectueuse incluant le secteur défectueux par la zone de remplacement incluant le secteur de réserve sont enregistrées, et un espace de volume (100a) dans lequel des données de l'utilisateur peuvent être enregistrées, dans lequel :

chacun des secteurs dans la zone d'enregistrement de données se voit affecter un numéro de secteur physique, dans la zone d'enregistrement de données, une seconde zone de réserve (108 ; 153 ; 158) comportant une zone de remplacement incluant un secteur de réserve (120 à 122) destinée à remplacer une zone défectueuse incluant un secteur défectueux parmi la pluralité de secteurs peut être allouée dans une zone comprenant un secteur présentant un numéro de secteur physique qui est plus grand qu'un numéro de secteur physique affecté au secteur de réserve (110 à 112) dans la première zone de réserve, et la seconde zone de réserve (108 ; 153 ; 158) peut être étendue dans une direction le long de laquelle le numéro de secteur physique diminue, et la zone d'informations de gestion de défauts (101) comporte une zone destinée à l'enregistrement d'informations d'emplacement qui indiquent l'allocation de la seconde zone de réserve (108 ; 153 ; 158).

2. Procédé d'enregistrement d'informations destiné à enregistrer des informations sur un support d'enregistrement d'informations incluant une pluralité de secteurs, le support d'enregistrement d'informations comprenant une zone d'enregistrement de données, la zone d'enregistrement de données incluant :

une première zone de réserve (102) comportant une zone de remplacement incluant un

secteur de réserve (110 à 112) destiné à remplacer une zone défectueuse incluant un secteur défectueux parmi la pluralité de secteurs, une zone d'informations de gestion de défauts (101) dans laquelle des informations de gestion de défauts destinées à gérer le remplacement de la zone défectueuse incluant le secteur défectueux par la zone de remplacement incluant le secteur de réserve sont enregistrées, et un espace de volume (100a) dans lequel des données de l'utilisateur peuvent être enregistrées, dans lequel :

dans la zone d'enregistrement de données, une seconde zone de réserve (108 ; 153 ; 158) comportant une zone de remplacement incluant un secteur de réserve (120 à 122) destiné à remplacer une zone défectueuse incluant un secteur défectueux parmi la pluralité de secteurs peut être étendue, et chacun du secteur de réserve dans la première zone de réserve (102) et du secteur de réserve dans la seconde zone de réserve (108 ; 153 ; 158) se voit affecter un numéro de secteur physique, et le numéro de secteur physique affecté au secteur de réserve dans la première zone de réserve est plus petit que le numéro de secteur physique affecté au secteur de réserve dans la seconde zone de réserve, le procédé d'enregistrement d'informations comprenant les étapes consistant à :

- (a) obtenir des informations qui indiquent une situation de la consommation de la seconde zone de réserve,
- (b) déterminer s'il faut ou non étendre, dans la zone d'enregistrement de données, la seconde zone de réserve comportant une zone de remplacement incluant un secteur de réserve en vue de remplacer une zone défectueuse incluant un secteur défectueux parmi la pluralité de secteurs, conformément aux informations qui indiquent la situation de la consommation de la seconde zone de réserve, et
- (c) lorsque la seconde zone de réserve est étendue, étendre la seconde zone de réserve dans une direction selon laquelle le numéro de secteur physique diminue.

3. Système d'enregistrement/reproduction d'informations destiné à un support d'enregistrement d'informations incluant une pluralité de secteurs, le support d'enregistrement d'informations comprenant

une zone d'enregistrement de données, la zone d'enregistrement de données incluant :

une première zone de réserve (102) comportant une zone de remplacement incluant un secteur de réserve (110 à 112) destiné à remplacer une zone défectueuse incluant un secteur défectueux parmi la pluralité de secteurs, une zone d'informations de gestion de défauts (101) dans laquelle des informations de gestion de défauts destinées à gérer le remplacement de la zone défectueuse incluant le secteur défectueux par la zone de remplacement incluant le secteur de réserve sont enregistrées, et un espace de volume (100a) dans lequel des données de l'utilisateur peuvent être enregistrées, dans lequel :

dans la zone d'enregistrement de données, une seconde zone de réserve (108 ; 153 ; 158) comportant une zone de remplacement incluant un secteur de réserve (120 à 122) destiné à remplacer une zone défectueuse incluant un secteur défectueux parmi la pluralité de secteurs peut être étendue, et chacun du secteur de réserve dans la première zone de réserve (102) et du secteur de réserve dans la seconde zone de réserve (108 ; 153 ; 158) se voit affecter un numéro de secteur physique, et le numéro de secteur physique affecté au secteur de réserve dans la première zone de réserve est plus petit que le numéro de secteur physique affecté au secteur de réserve dans la seconde zone de réserve, le système d'enregistrement/reproduction d'informations comprenant :

une section de détection de quantité de zone de réserve restante (233) destinée à obtenir des informations qui indiquent une situation de la consommation de la seconde zone de réserve, une section de détermination d'extension de zone de réserve (215) destinée à déterminer s'il faut ou non étendre, dans la zone d'enregistrement de données, la seconde zone de réserve comportant une zone de remplacement incluant un secteur de réserve en vue de remplacer une zone défectueuse incluant un secteur défectueux parmi la pluralité de secteurs conformément aux informations qui indiquent la situation de la consommation de la seconde zone de réserve, et une section d'allocation de zone d'ex-

tension de réserve (214, 232) destinée à étendre, lorsque la seconde zone de réserve est étendue, la seconde zone de réserve dans une direction suivant laquelle le numéro de secteur physique diminue.

FIG. 1

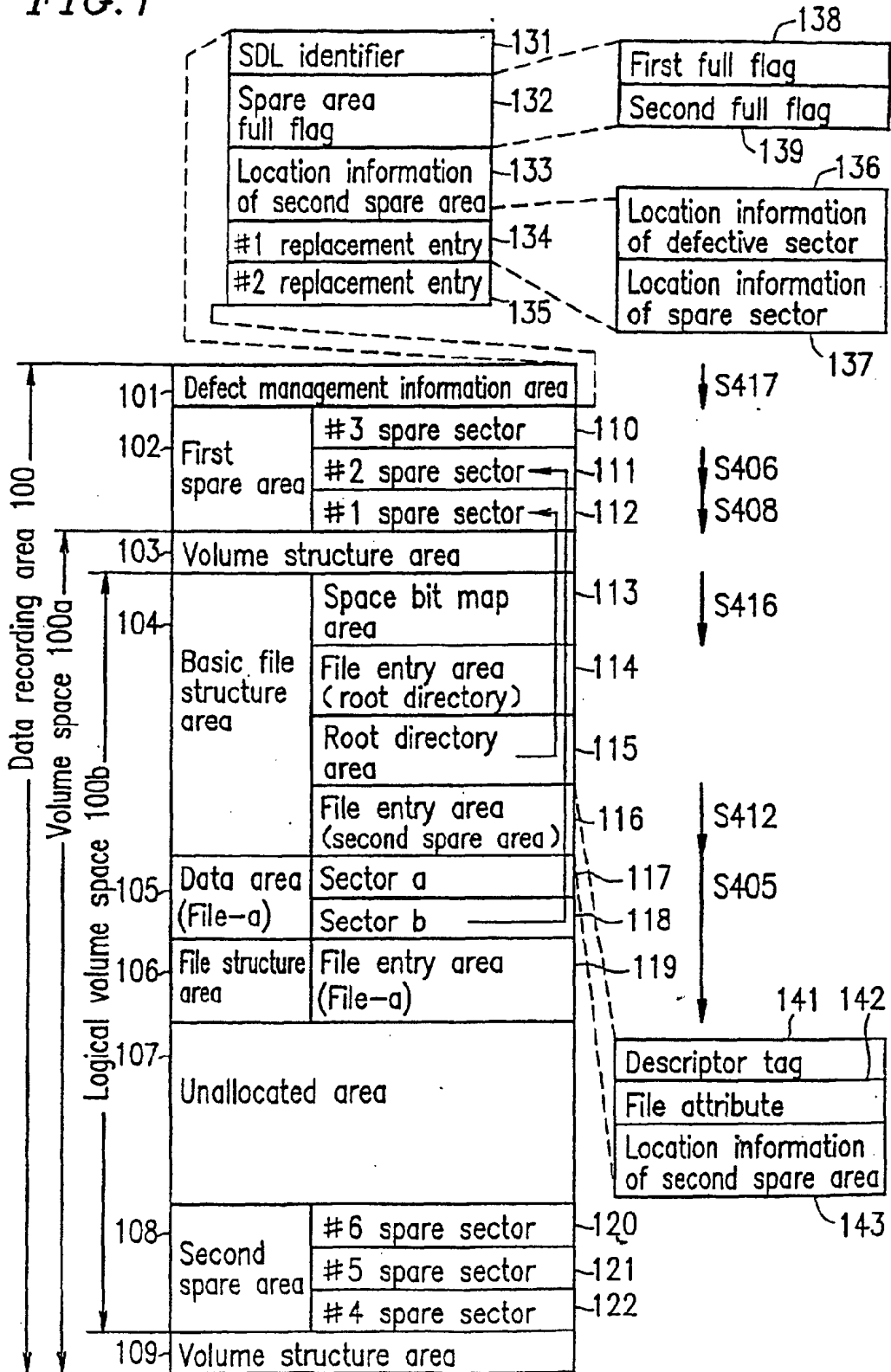

FIG. 2

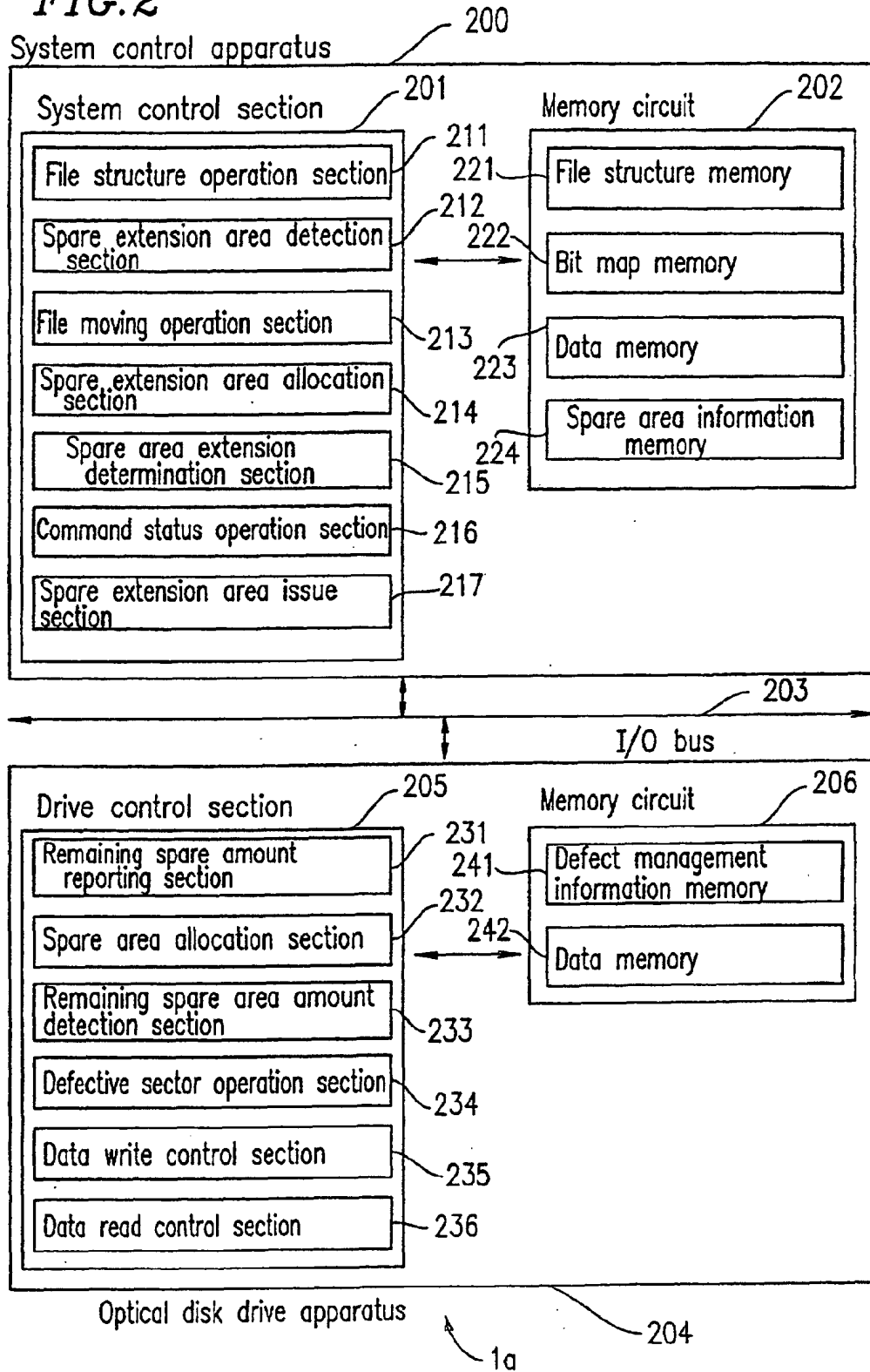

FIG. 3

Operation of optical disk drive apparatus Operation of system control apparatus

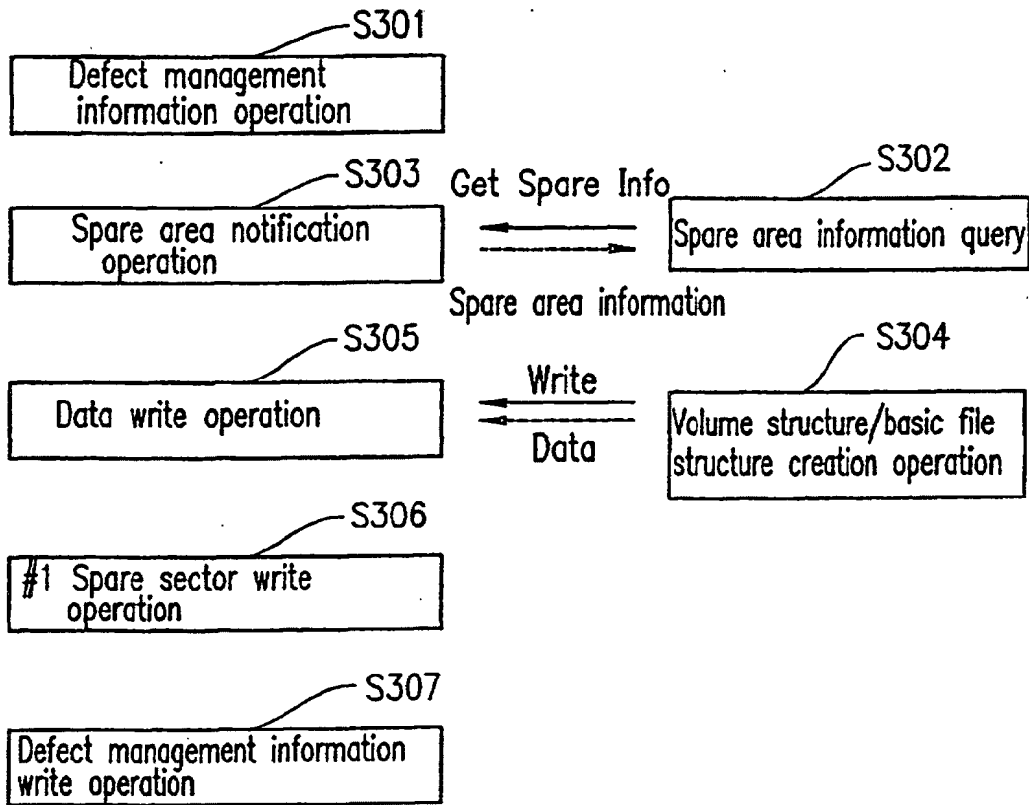

FIG. 4

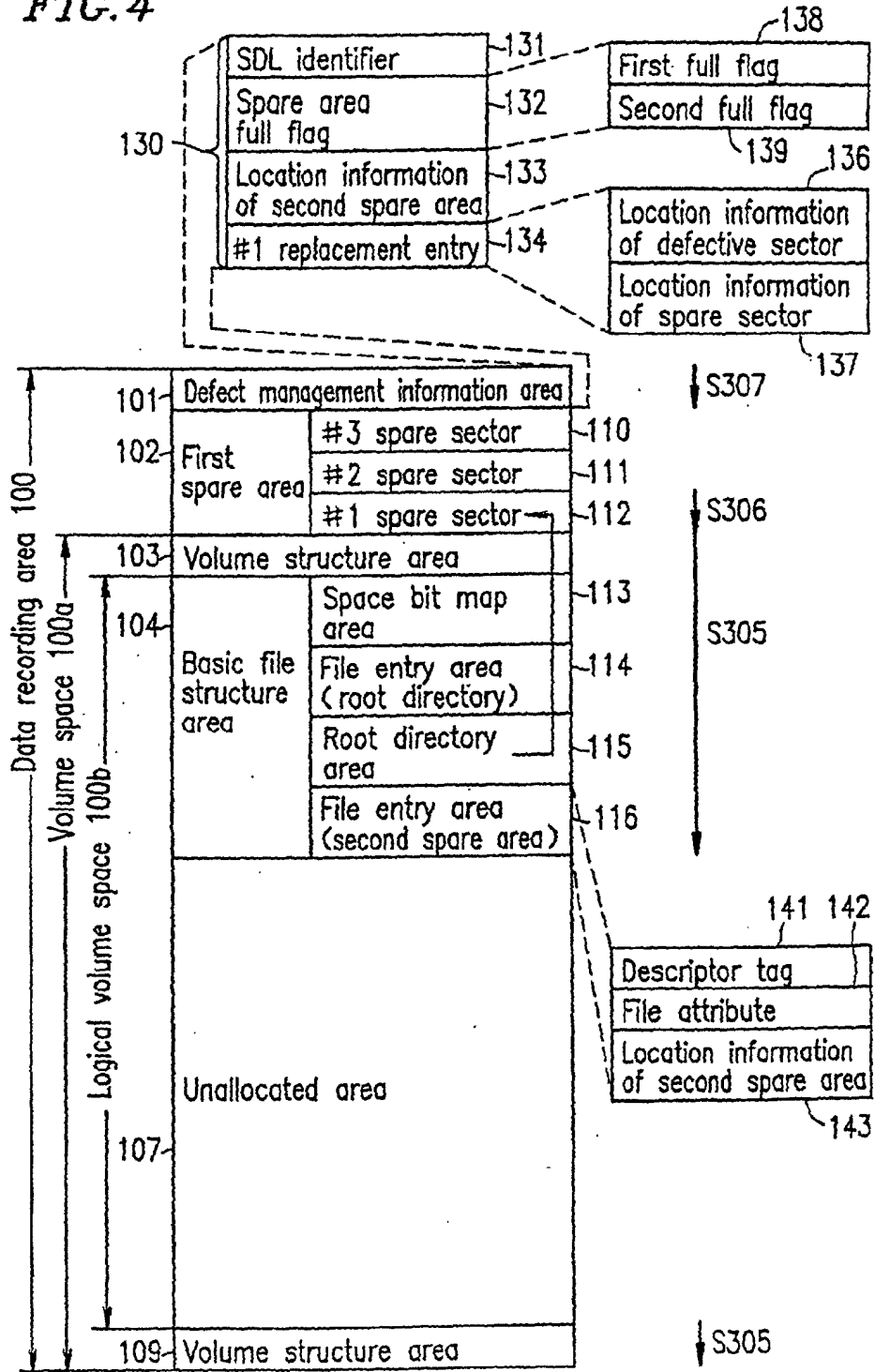

FIG. 5

Operation of optical disk drive apparatus

Operation of system control apparatus

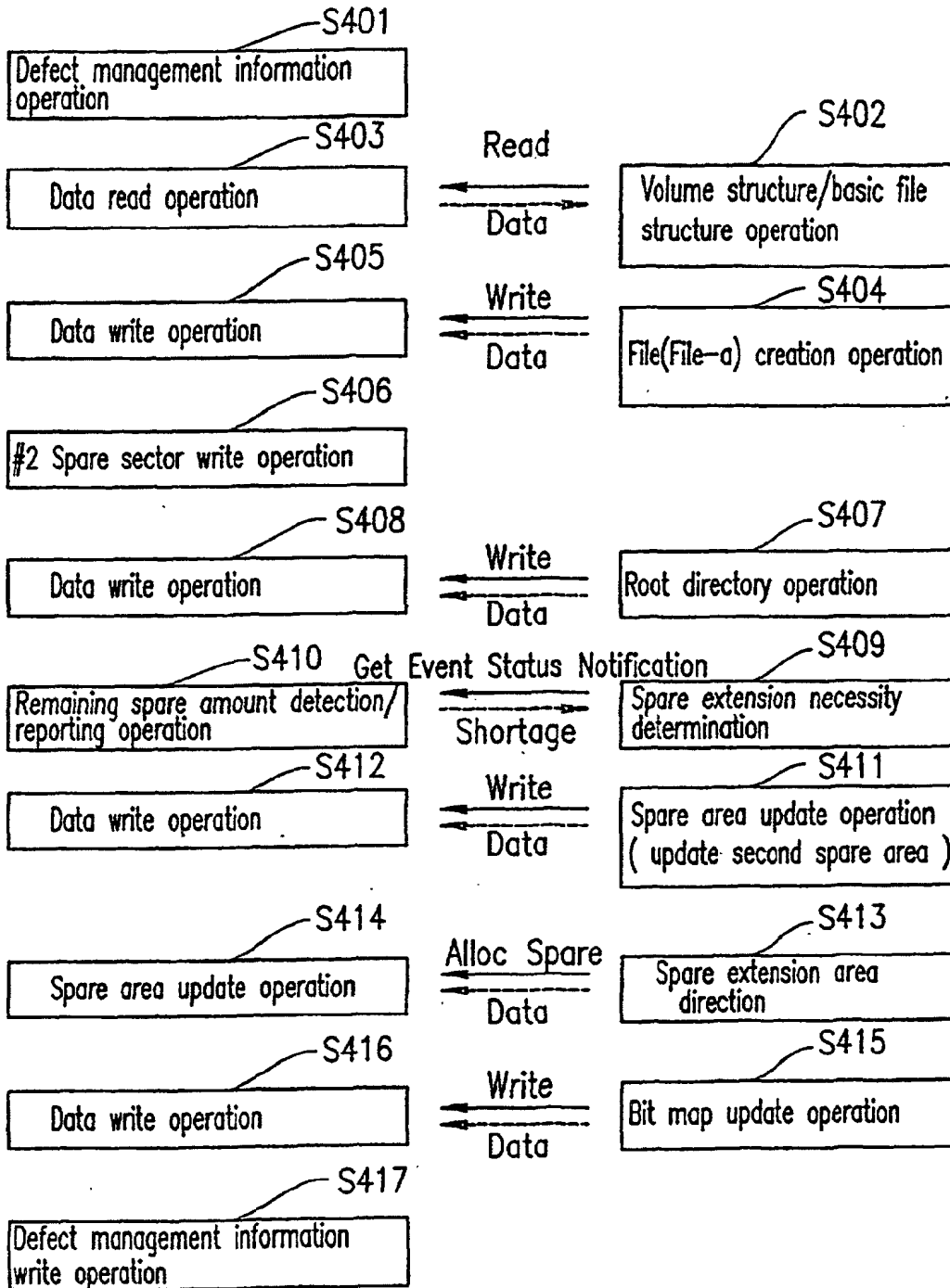

FIG. 6A

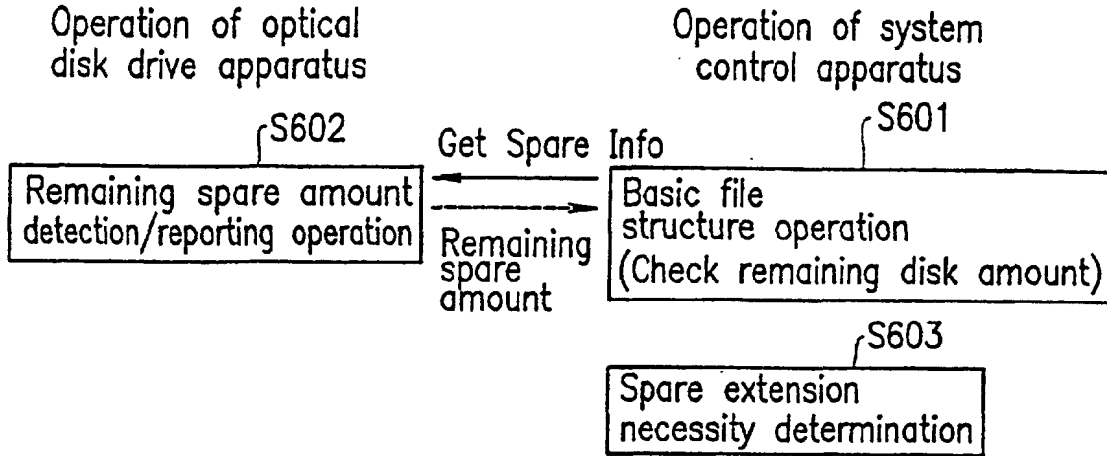

FIG. 6B

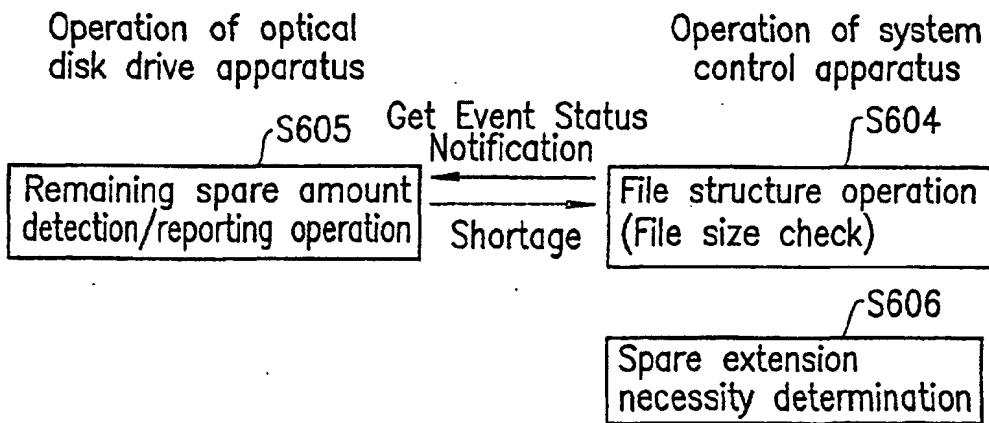

FIG. 6C

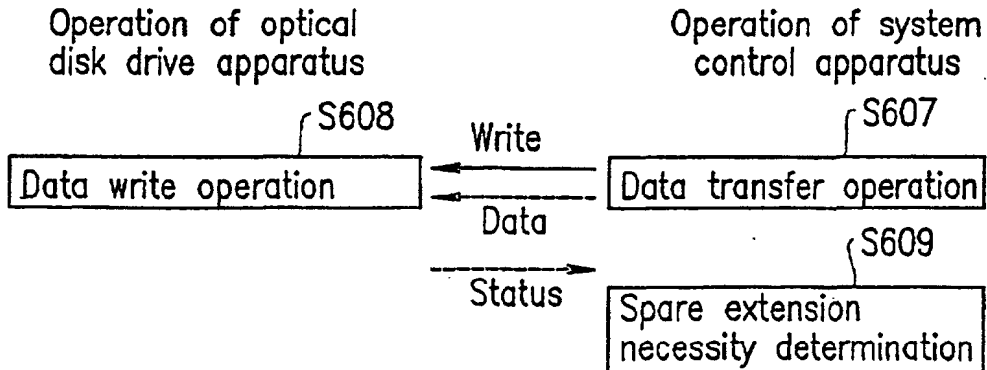
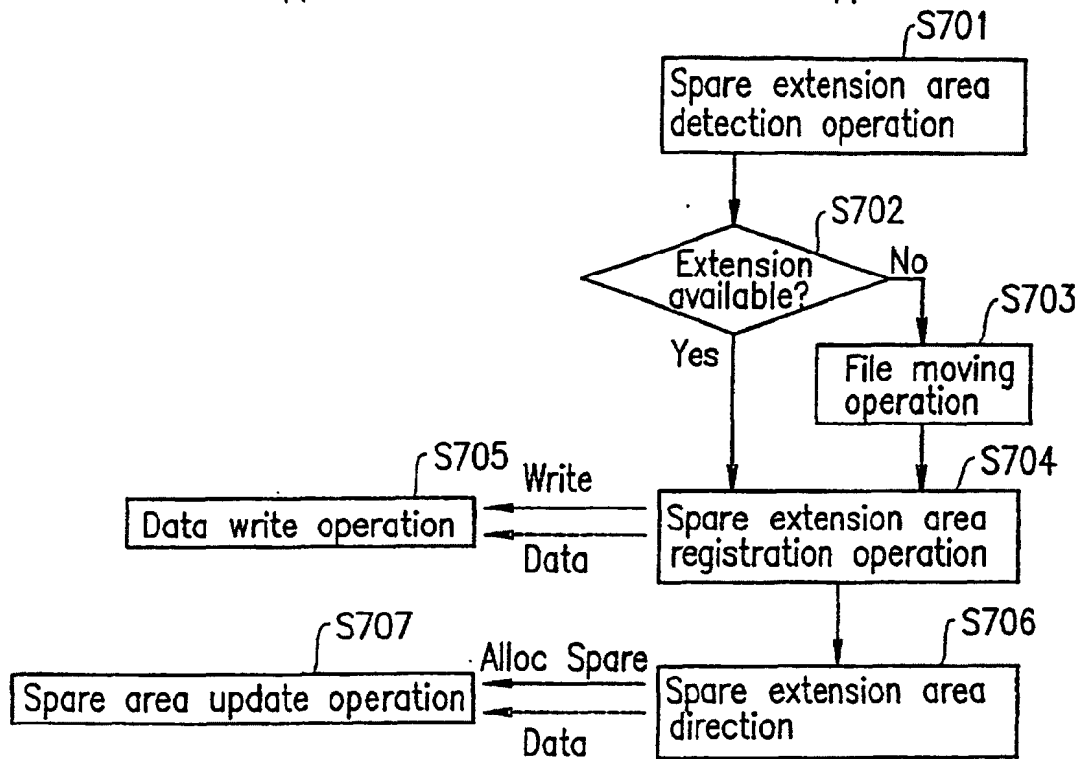

FIG. 7

Operation of optical disk drive apparatus

Operation of system control apparatus



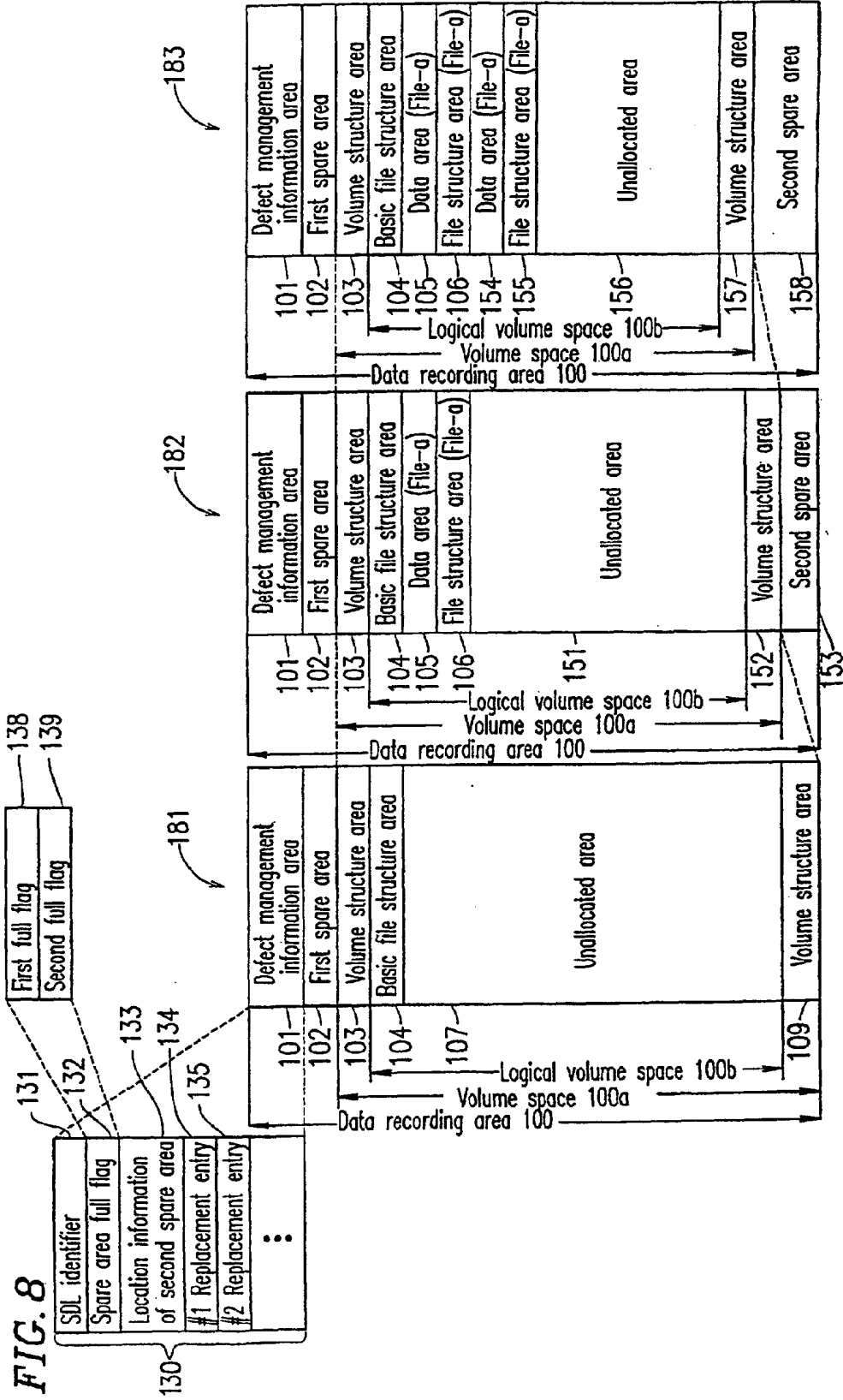

FIG. 9

Operation of optical disk drive apparatus

Operation of system control apparatus

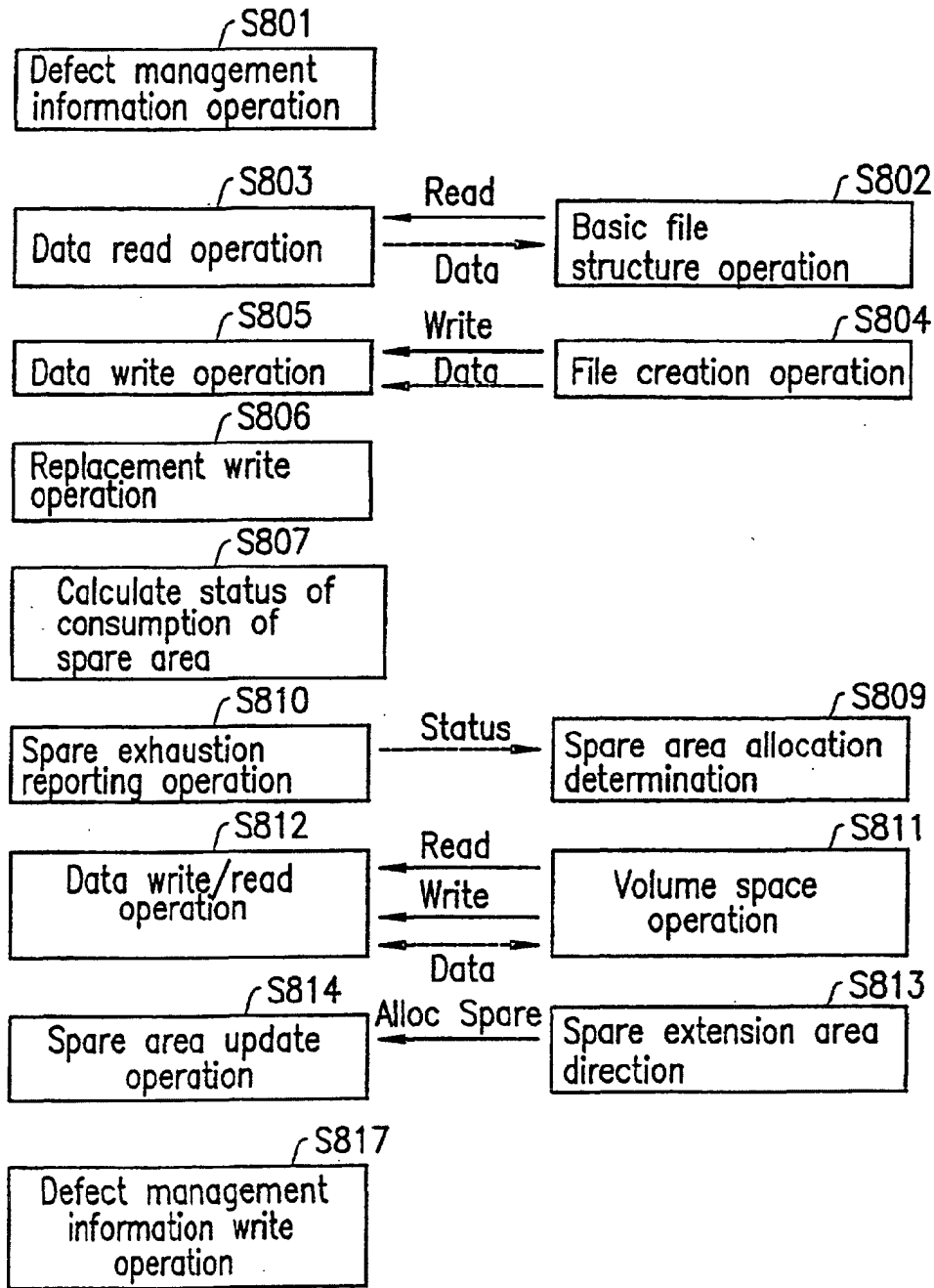
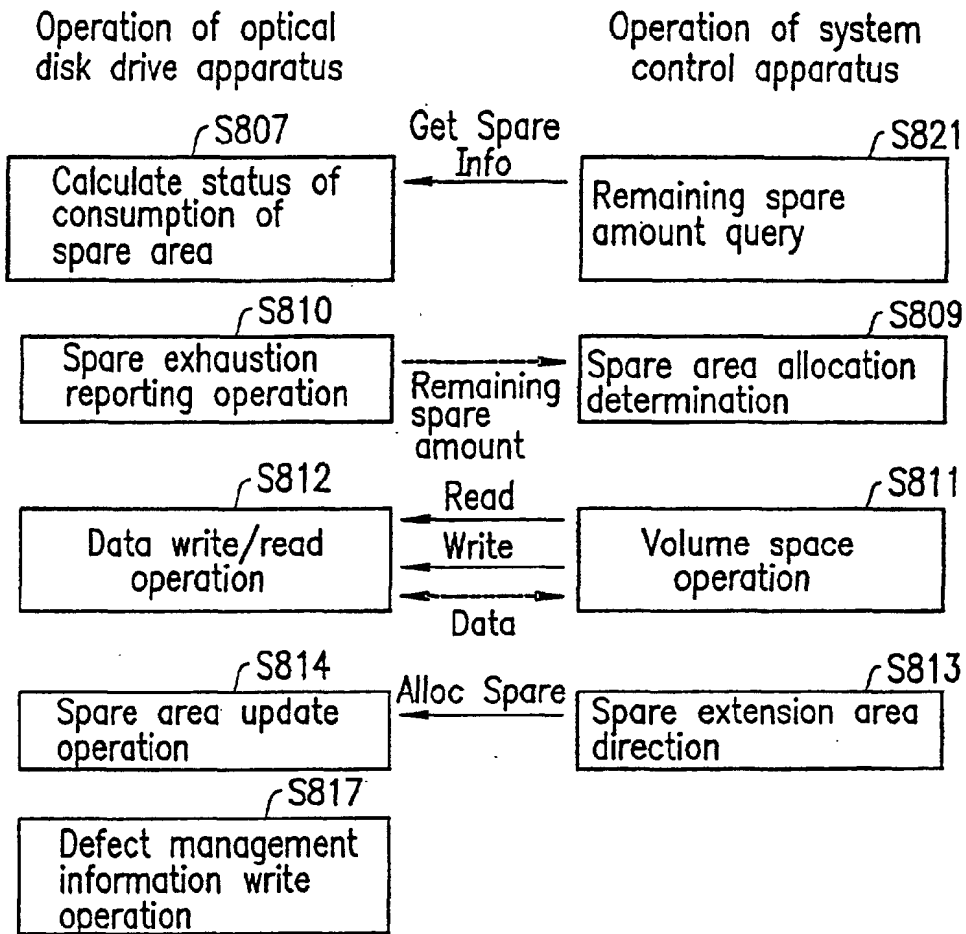

FIG. 10



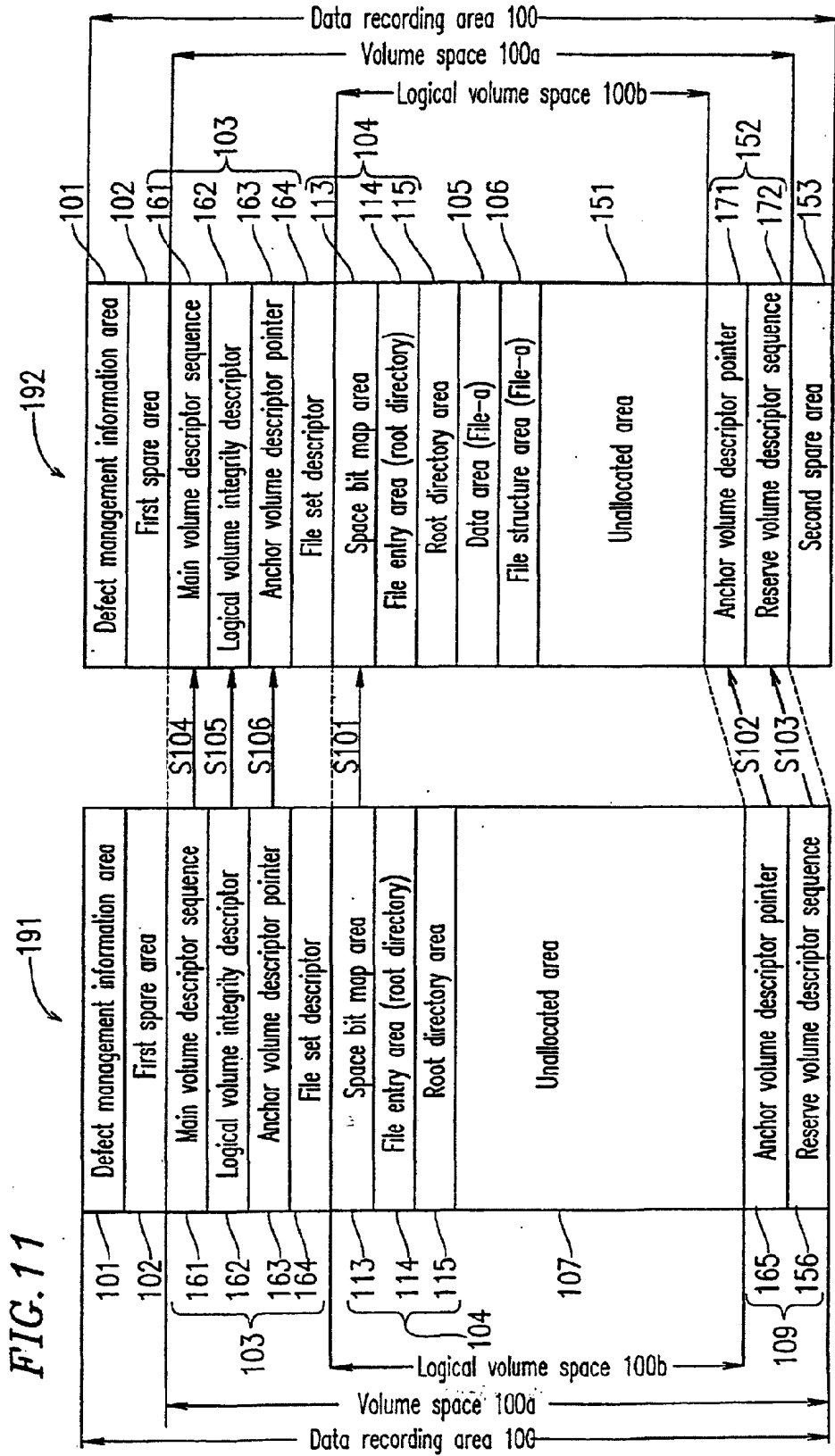

FIG. 12

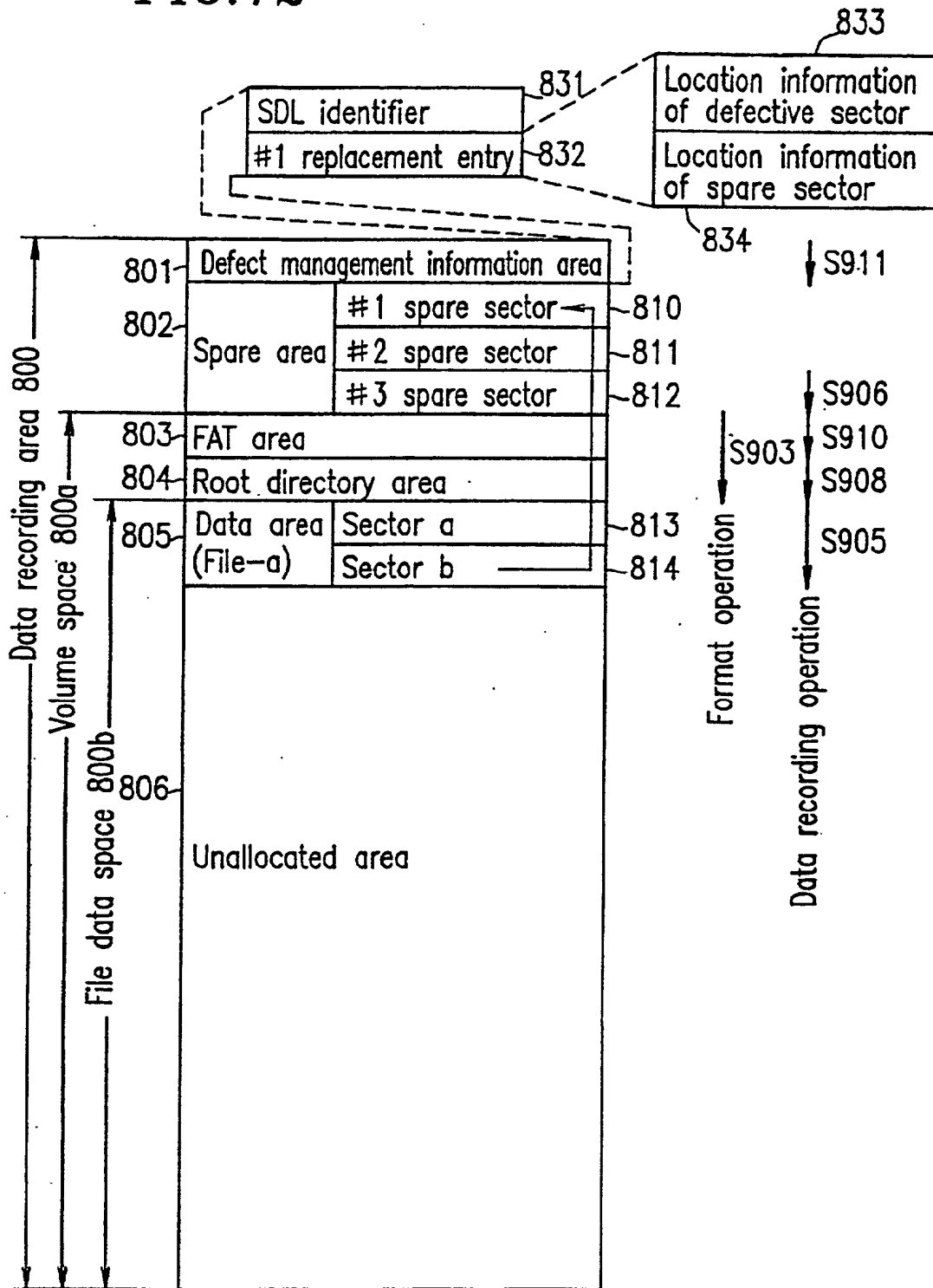

FIG. 13

